



Seller disclosure statement

Property Law Act 2023 section 99

Form 2, Version 1 | Effective from: 1 August 2025

WARNING TO BUYER – This statement contains important legal and other information about the property offered for sale. You should read and satisfy yourself of the information in this statement before signing a contract. You are advised to seek legal advice before signing this form. You should not assume you can terminate the contract after signing if you are not satisfied with the information in this statement.

WARNING – You must be given this statement before you sign the contract for the sale of the property.

This statement does not include information about:

- » flooding or other natural hazard history
- » structural soundness of the building or pest infestation
- » current or historical use of the property
- » current or past building or development approvals for the property
- » limits imposed by planning laws on the use of the land
- » services that are or may be connected to the property
- » the presence of asbestos within buildings or improvements on the property.

You are encouraged to make your own inquiries about these matters before signing a contract. You may not be able to terminate the contract if these matters are discovered after you sign.

Part 1 – Seller and property details

Seller **Irene Carter**

Property address
(referred to as the
"property" in this
statement)

24 ALKOOMIE ST, WYNNUM QLD 4178

Lot on plan description

1/RP71015

Community titles scheme
or BUGTA scheme:

Is the property part of a community titles scheme or a BUGTA scheme:

Yes

*If Yes, refer to Part 6 of this statement
for additional information*

No

*If No, please disregard Part 6 of this statement
as it does not need to be completed*

Part 2 – Title details, encumbrances and residential tenancy or rooming accommodation agreement

Title details

The seller gives or has given the buyer the following—

A title search for the property issued under the *Land Title Act 1994* showing interests registered under that Act for the property.

Yes

A copy of the plan of survey registered for the property.

Yes

Registered encumbrances	<p>Registered encumbrances, if any, are recorded on the title search, and may affect your use of the property. Examples include easements, statutory covenants, leases and mortgages.</p> <p>You should seek legal advice about your rights and obligations before signing the contract.</p>
Unregistered encumbrances (excluding statutory encumbrances)	<p>There are encumbrances not registered on the title that will continue <input type="checkbox"/> Yes <input checked="" type="checkbox"/> No to affect the property after settlement.</p> <p>Note—If the property is part of a community titles scheme or a BUGTA scheme it may be subject to and have the benefit of statutory easements that are NOT required to be disclosed.</p> <p>Unregistered lease (if applicable)</p> <p>If the unregistered encumbrance is an unregistered lease, the details of the agreement are as follows:</p> <ul style="list-style-type: none"> » the start and end day of the term of the lease: <input style="width: 100%;" type="text"/> » the amount of rent and bond payable: <input style="width: 100%;" type="text"/> » whether the lease has an option to renew: <input style="width: 100%;" type="text"/> <p>Other unregistered agreement in writing (if applicable)</p> <p>If the unregistered encumbrance is created by an agreement in writing, and is not an unregistered lease, a copy of the agreement is given, together with relevant plans, if any. <input type="checkbox"/> Yes</p> <p>Unregistered oral agreement (if applicable)</p> <p>If the unregistered encumbrance is created by an oral agreement, and is not an unregistered lease, the details of the agreement are as follows:</p> <div style="border: 1px solid black; height: 100px; width: 100%;"></div>
Statutory encumbrances	<p>There are statutory encumbrances that affect the property. <input checked="" type="checkbox"/> Yes <input type="checkbox"/> No</p> <p><i>If Yes, the details of any statutory encumbrances are as follows:</i></p> <div style="border: 1px solid black; padding: 5px;"> <p>All statutory encumbrances or rights for water supply, gas, sewerage, drainage or other utilities including but not limited to the Council’s stormwater gully/roof water connection, Energex assets, NBN assets, water utilities infrastructure and Telstra cable as per the attached Dial-Before-You-Dig searches.</p> </div>
Residential tenancy or rooming accommodation agreement	<p>The property has been subject to a residential tenancy agreement or a rooming accommodation agreement under the <i>Residential Tenancies and Rooming Accommodation Act 2008</i> during the last 12 months. <input type="checkbox"/> Yes <input checked="" type="checkbox"/> No</p> <p>If Yes, when was the rent for the premises or each of the residents’ rooms last increased? (<i>Insert date of the most recent rent increase for the premises or rooms</i>) <input style="width: 100%;" type="text"/></p> <p>Note—Under the <i>Residential Tenancies and Rooming Accommodation Act 2008</i> the rent for a residential premises may not be increased earlier than 12 months after the last rent increase for the premises.</p> <p>As the owner of the property, you may need to provide evidence of the day of the last rent increase. You should ask the seller to provide this evidence to you prior to settlement.</p>

Part 3 – Land use, planning and environment

WARNING TO BUYER – You may not have any rights if the current or proposed use of the property is not lawful under the local planning scheme. You can obtain further information about any planning and development restrictions applicable to the lot, including in relation to short-term letting, from the relevant local government.

Zoning	<p>The zoning of the property is (<i>Insert zoning under the planning scheme, the Economic Development Act 2012; the Integrated Resort Development Act 1987; the Mixed Use Development Act 1993; the State Development and Public Works Organisation Act 1971 or the Sanctuary Cove Resort Act 1985, as applicable</i>):</p> <div style="border: 1px solid black; padding: 5px; width: fit-content;"> <p>Low Density Residential</p> </div>	
Transport proposals and resumptions	<p>The lot is affected by a notice issued by a Commonwealth, State or local government entity and given to the seller about a transport infrastructure proposal* to: locate transport infrastructure on the property; or alter the dimensions of the property.</p> <p style="text-align: right;"><input type="checkbox"/> Yes <input checked="" type="checkbox"/> No</p> <p>The lot is affected by a notice of intention to resume the property or any part of the property.</p> <p style="text-align: right;"><input type="checkbox"/> Yes <input checked="" type="checkbox"/> No</p> <p><i>If Yes, a copy of the notice, order, proposal or correspondence must be given by the seller.</i></p>	
<p>* <i>Transport infrastructure</i> has the meaning defined in the <i>Transport Infrastructure Act 1994</i>. A <i>proposal</i> means a resolution or adoption by some official process to establish plans or options that will physically affect the property.</p>		
Contamination and environmental protection	<p>The property is recorded on the Environmental Management Register or the Contaminated Land Register under the <i>Environmental Protection Act 1994</i>.</p> <p style="text-align: right;"><input type="checkbox"/> Yes <input checked="" type="checkbox"/> No</p> <p>The following notices are, or have been, given:</p> <p>A notice under section 408(2) of the <i>Environmental Protection Act 1994</i> (for example, land is contaminated, show cause notice, requirement for site investigation, clean up notice or site management plan).</p> <p style="text-align: right;"><input type="checkbox"/> Yes <input checked="" type="checkbox"/> No</p> <p>A notice under section 369C(2) of the <i>Environmental Protection Act 1994</i> (the property is a place or business to which an environmental enforcement order applies).</p> <p style="text-align: right;"><input type="checkbox"/> Yes <input checked="" type="checkbox"/> No</p> <p>A notice under section 347(2) of the <i>Environmental Protection Act 1994</i> (the property is a place or business to which a prescribed transitional environmental program applies).</p> <p style="text-align: right;"><input type="checkbox"/> Yes <input checked="" type="checkbox"/> No</p>	
Trees	<p>There is a tree order or application under the <i>Neighbourhood Disputes (Dividing Fences and Trees) Act 2011</i> affecting the property.</p> <p style="text-align: right;"><input type="checkbox"/> Yes <input checked="" type="checkbox"/> No</p> <p><i>If Yes, a copy of the order or application must be given by the seller.</i></p>	
Heritage	<p>The property is affected by the <i>Queensland Heritage Act 1992</i> or is included in the World Heritage List under the <i>Environment Protection and Biodiversity Conservation Act 1999</i> (Cwlth).</p> <p style="text-align: right;"><input type="checkbox"/> Yes <input checked="" type="checkbox"/> No</p>	
Flooding	<p>Information about whether the property is affected by flooding or another natural hazard or within a natural hazard overlay can be obtained from the relevant local government and you should make your own enquires. Flood information for the property may also be available at the FloodCheck Queensland portal or the Australian Flood Risk Information portal.</p>	
Vegetation, habitats and protected plants	<p>Information about vegetation clearing, koala habitats and other restrictions on development of the land that may apply can be obtained from the relevant State government agency.</p>	

Part 4 – Buildings and structures

WARNING TO BUYER – The seller does not warrant the structural soundness of the buildings or improvements on the property, or that the buildings on the property have the required approval, or that there is no pest infestation affecting the property. You should engage a licensed building inspector or an appropriately qualified engineer, builder or pest inspector to inspect the property and provide a report and also undertake searches to determine whether buildings and improvements on the property have the required approvals.

Swimming pool	There is a relevant pool for the property.	<input checked="" type="checkbox"/> Yes	<input type="checkbox"/> No
	If a community titles scheme or a BUGTA scheme – a shared pool is located in the scheme.	<input type="checkbox"/> Yes	<input checked="" type="checkbox"/> No
	Pool compliance certificate is given.	<input checked="" type="checkbox"/> Yes	<input type="checkbox"/> No
	OR Notice of no pool safety certificate is given.	<input type="checkbox"/> Yes	<input checked="" type="checkbox"/> No
Unlicensed building work under owner builder permit	Building work was carried out on the property under an owner builder permit in the last 6 years.	<input type="checkbox"/> Yes	<input checked="" type="checkbox"/> No
	<i>A notice under section 47 of the Queensland Building and Construction Commission Act 1991 must be given by the seller and you may be required to sign the notice and return it to the seller prior to signing the contract.</i>		
Notices and orders	There is an unsatisfied show cause notice or enforcement notice under the <i>Building Act 1975</i> , section 246AG, 247 or 248 or under the <i>Planning Act 2016</i> , section 167 or 168.	<input type="checkbox"/> Yes	<input checked="" type="checkbox"/> No
	The seller has been given a notice or order, that remains in effect, from a local, State or Commonwealth government, a court or tribunal, or other competent authority, requiring work to be done or money to be spent in relation to the property.	<input type="checkbox"/> Yes	<input checked="" type="checkbox"/> No
	<i>If Yes, a copy of the notice or order must be given by the seller.</i>		
Building Energy Efficiency Certificate	If the property is a commercial office building of more than 1,000m ² , a Building Energy Efficiency Certificate is available on the Building Energy Efficiency Register.		
Asbestos	The seller does not warrant whether asbestos is present within buildings or improvements on the property. Buildings or improvements built before 1990 may contain asbestos. Asbestos containing materials (ACM) may have been used up until the early 2000s. Asbestos or ACM may become dangerous when damaged, disturbed, or deteriorating. Information about asbestos is available at the Queensland Government Asbestos Website (asbestos.qld.gov.au) including common locations of asbestos and other practical guidance for homeowners.		

Part 5 – Rates and services

WARNING TO BUYER – The amount of charges imposed on you may be different to the amount imposed on the seller.

Rates

Whichever of the following applies—

The total amount payable* for all rates and charges (without any discount) for the property as stated in the most recent rate notice is:

Amount:

Date Range:

OR

The property is currently a rates exempt lot.**

OR

The property is not rates exempt but no separate assessment of rates is issued by a local government for the property.

*Concessions: A local government may grant a concession for rates. The concession will not pass to you as buyer unless you meet the criteria in section 120 of the *Local Government Regulation 2012* or section 112 of the *City of Brisbane Regulation 2012*.

** An exemption for rates applies to particular entities. The exemption will not pass to you as buyer unless you meet the criteria in section 93 of the *Local Government Act 2009* or section 95 of the *City of Brisbane Act 2010*.

Water

Whichever of the following applies—

The total amount payable as charges for water services for the property as indicated in the most recent water services notice* is:

Amount:

Date Range:

OR

There is no separate water services notice issued for the lot; however, an estimate of the total amount payable for water services is:

Amount:

Date Range:

* A water services notices means a notice of water charges issued by a water service provider under the *Water Supply (Safety and Reliability) Act 2008*.

Part 6 – Community titles schemes and BUGTA schemes

(If the property is part of a community titles scheme or a BUGTA scheme this Part must be completed)

WARNING TO BUYER – If the property is part of a community titles scheme or a BUGTA scheme and you purchase the property, you will become a member of the body corporate for the scheme with the right to participate in significant decisions about the scheme and you will be required to pay contributions towards the body corporate’s expenses in managing the scheme. You will also be required to comply with the by-laws. By-laws will regulate your use of common property and the lot.

For more information about living in a body corporate and your rights and obligations, contact the Office of the Commissioner for Body Corporate and Community Management.

<p>Body Corporate and Community Management Act 1997</p>	<p>The property is included in a community titles scheme. (If Yes, complete the information below)</p>	<input type="checkbox"/> Yes	<input checked="" type="checkbox"/> No
<p>Community Management Statement</p>	<p>A copy of the most recent community management statement for the scheme as recorded under the <i>Land Title Act 1994</i> or another Act is given to the buyer.</p> <p>Note—If the property is part of a community titles scheme, the community management statement for the scheme contains important information about the rights and obligations of owners of lots in the scheme including matters such as lot entitlements, by-laws and exclusive use areas.</p>	<input type="checkbox"/> Yes	
<p>Body Corporate Certificate</p>	<p>A copy of a body corporate certificate for the lot under the <i>Body Corporate and Community Management Act 1997</i>, section 205(4) is given to the buyer.</p> <p>If No— An explanatory statement is given to the buyer that states:</p> <ul style="list-style-type: none"> » a copy of a body corporate certificate for the lot is not attached; and » the reasons under section 6 of the <i>Property Law Regulation 2024</i> why the seller has not been able to obtain a copy of the body corporate certificate for the lot. 	<input type="checkbox"/> Yes	<input type="checkbox"/> No
<p>Statutory Warranties</p>	<p>Statutory Warranties—If you enter into a contract, you will have implied warranties under the <i>Body Corporate and Community Management Act 1997</i> relating to matters such as latent or patent defects in common property or body corporate assets; any actual, expected or contingent financial liabilities that are not part of the normal operating costs; and any circumstances in relation to the affairs of the body corporate that will materially prejudice you as owner of the property. There will be further disclosure about warranties in the contract.</p>	<input type="checkbox"/> Yes	
<p>Building Units and Group Titles Act 1980</p>	<p>The property is included in a BUGTA scheme (If Yes, complete the information below)</p>	<input type="checkbox"/> Yes	<input checked="" type="checkbox"/> No
<p>Body Corporate Certificate</p>	<p>A copy of a body corporate certificate for the lot under the <i>Building Units and Group Titles Act 1980</i>, section 40AA(1) is given to the buyer.</p> <p>If No— An explanatory statement is given to the buyer that states:</p> <ul style="list-style-type: none"> » a copy of a body corporate certificate for the lot is not attached; and » the reasons under section 7 of the <i>Property Law Regulation 2024</i> why the seller has not been able to obtain a copy of the body corporate certificate for the lot. <p>Note—If the property is part of a BUGTA scheme, you will be subject to by-laws approved by the body corporate and other by-laws that regulate your use of the property and common property.</p>	<input type="checkbox"/> Yes	<input type="checkbox"/> No

Signatures – SELLER

Signed by:

Irene Carter

EF9678A20AF74F2...

Signature of seller

Signature of seller

Irene Carter

Name of Seller

Name of Seller

20/11/2025

Date

Date

Signatures – BUYER

By signing this disclosure statement the buyer acknowledges receipt of this disclosure statement before entering into a contract with the seller for the sale of the lot.

Signature of buyer

Signature of buyer

Name of buyer

Name of buyer

Date

Date

CURRENT TITLE SEARCH
QUEENSLAND TITLES REGISTRY PTY LTD



Request No: 54166634
Search Date: 20/11/2025 09:12

Title Reference: 12736248
Date Created: 30/03/1953

Previous Title: 12703211
12703212
12703213

REGISTERED OWNER

Dealing No: 716073376 14/10/2014

IRENE CARTER

ESTATE AND LAND

Estate in Fee Simple

LOT 1 REGISTERED PLAN 71015
Local Government: BRISBANE CITY

EASEMENTS, ENCUMBRANCES AND INTERESTS

1. Rights and interests reserved to the Crown by
Deed of Grant No. 19502079 (POR 62)
2. MORTGAGE No 716073377 14/10/2014 at 11:24
AUSTRALIA AND NEW ZEALAND BANKING GROUP LIMITED A.B.N. 11
005 357 522

ADMINISTRATIVE ADVICES - NIL
UNREGISTERED DEALINGS - NIL

Caution - Charges do not necessarily appear in order of priority

** End of Current Title Search **

COPYRIGHT QUEENSLAND TITLES REGISTRY PTY LTD [2025]
Requested By: D-ENQ INFOTRACK PTY LIMITED

THIS PLAN should be ROLLED not folded.
— FOR OFFICE USE ONLY —

C.T. 393483 2061-73 33068A

Attest and certify that I have personally and correctly surveyed and correctly measured the boundaries and contents of the land shown in this plan and that the measurements and contents shown in this plan are correct and true to the best of my belief and are in conformity with the provisions of the Act relating to the registration of titles in Queensland.

BRISBANE CITY COUNCIL CONSENTS
TO THIS PLAN OF SUBDIVISION.

J. MacFarlane
DEPUTY TOWN CLERK 3/17/50

RECORD DESCRIPTION
This description takes effect upon assignment of the current Title Deed which will be evidenced by a further notation
Survey of Lot (s) 142
on R.P. 71015

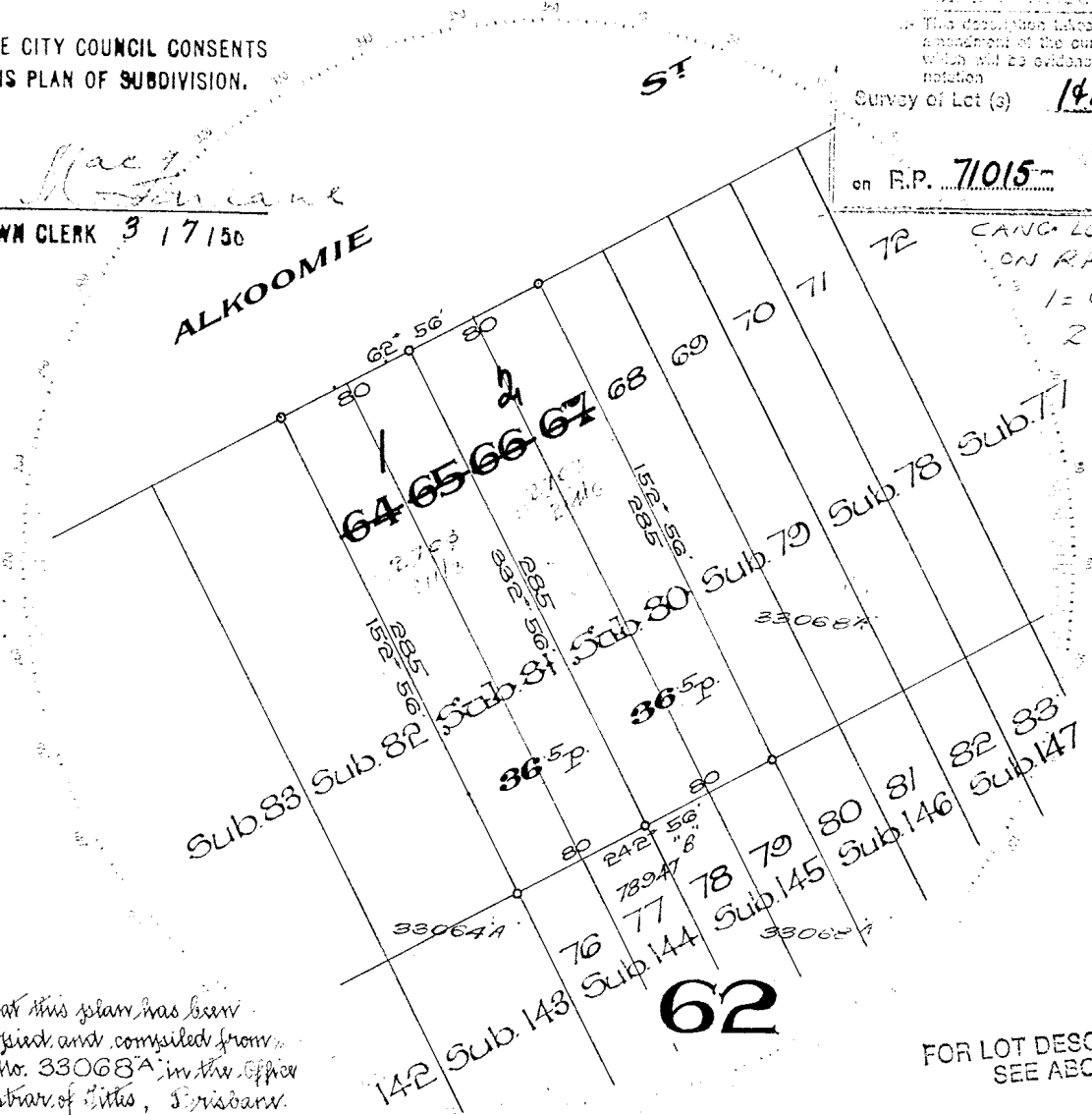

CANG. LOTS 64-67
ON RP 33068
1 = 64, 65
2 = 66, 67
S
N
N
N

I certify that this plan has been correctly copied and compiled from Plan Cat. No. 33068A in the Office of the Registrar of Titles, Brisbane.

Thomas J. Moor
M.A. Surveyor.
6. 2. 50

City of Brisbane
PLAN

5 7 50
93/136 30/5
14 8 50
14 8 50
DEPUTY REGISTRAR OF TITLES
71015

RE
THIS DIVISIONS 64 to 67 of
Subs. 80 and 81
62

Stanley
Tingalpa
71015 Cat. No. 71015 CISP

71015

0946551

2061
/73

For Additional Plan &
Document Notings
Refer to CISP

387929

G.L. EYTH, City Solicitor
TOWN HALL, BRESKANE

1. 100
000

2. 1.000
Eu

30.3.50 0946551

2061-73

71015

A pool safety certificate is required in Queensland when selling or leasing a property with a regulated pool. This form is to be used for the purposes of sections 246AA and 246AK of the *Building Act 1975*.

1. Pool safety certificate number

Identification number:

2. Location of the swimming pool

Property details are usually shown on the title documents and rates notices

Street address:

Postcode

Lot and plan details:

Local government area:

3. Exemptions or alternative solutions for the swimming pool (if applicable)

If an exemption or alternative solution is applicable to the swimming pool please state this. This will help provide pool owners with a concise and practical explanation of the exemption or alternative solution. It will also help to ensure the ongoing use of the pool and any future modifications do not compromise compliance with the pool safety standard.

4. Pool properties

Shared pool

Non-shared pool

Number of pools

5. Pool safety certificate validity

Effective date:

/

/

Expiry date:

/

/

6. Certification

I certify that I have inspected the swimming pool and I am reasonably satisfied that, under the *Building Act 1975*, the pool is a complying pool.

Name:

Pool safety inspector licence number:

Signature:



Other important information that could help save a young child's life

It is the pool owner's responsibility to ensure that the pool (including the barriers for the pool) is properly maintained at all times to comply with the pool safety standard under the *Building Act 1975*. High penalties apply for non-compliance. Parents should also consider beginning swimming lessons for their young children from an early age. Please visit

<https://www.qbcc.qld.gov.au/your-property/swimming-pools/pool-safety-standard> for further information about swimming pool safety. This pool safety certificate does not certify that a building development approval has been given for the pool or the barriers for the pool. You can contact your local government to ensure this approval is in place.

Privacy statement

The Queensland Building and Construction Commission is collecting personal information as required under the *Building Act 1975*. This information may be stored by the QBCC, and will be used for administration, compliance, statistical research and evaluation of pool safety laws. Your personal information will be disclosed to other government agencies, local government authorities and third parties for purposes relating to administering and monitoring compliance with the Building Act 1975. Personal information will otherwise only be disclosed to third parties with your consent or unless authorised or required by law.

RTI: The information collected on this form will be retained as required by the *Public Records Act 2002* and other relevant Acts and regulations, and is subject to the Right to Information regime established by the *Right to Information Act 2009*.

This is a public document and the information in this form will be made available to the public.

Job ID 51611592

24 Alkoomie St



[Review responses online](#) ↗

	<p>Received 5 of 5 responses All responses received</p> <p>24 Alkoomie St, Wynnum QLD 4178</p> <p>Job dates 05/11/2025 → 05/11/2025</p> <p>These plans expire on 3 Dec 2025</p> <p>Lodged by Info Request HPC</p>
--	--

Authority	Status	Page
✉ BYDA Confirmation		2
🏠 APA Group Gas Networks (90073)	Received	4
🏠 Brisbane City Council	Received	56
🏠 NBN Co Qld	Received	59
🏠 Queensland Urban Utilities	Received	70
🏠 Telstra QLD South East	Received	75

Job No 51611592



byda.com.au

Contact Details

Contact Info Request HPC	Contact number (07) 3397 4280	Company -	Enquirer ID 3748544
Email inforequest.hpc@harcourts.com.au		Address 15 Harries Road Coorparoo QLD 4151	

Job Site and Enquiry Details

WARNING: The map below only displays the location of the proposed job site and does not display any asset owners' pipe or cables. The area highlighted has been used only to identify the participating asset owners, who will send information to you directly.

Enquiry date 05/11/2025	Start date 05/11/2025	End date 05/11/2025	On behalf of Private	Job purpose Design	Locations Private	Onsite activities Planning & Design
-----------------------------------	---------------------------------	-------------------------------	--------------------------------	------------------------------	-----------------------------	---



Check that the location of the job site is correct. If not, you must submit a new enquiry.

If the scope of works change or plan validity dates expire, you must submit a new enquiry.

Do NOT dig without plans. Safe excavation is your responsibility. If you don't understand the plans or how to proceed safely, please contact the relevant asset owners.

User Reference 24 Alkoomie St	Address 24 Alkoomie St Wynnum QLD 4178	Notes/description -
---	---	-------------------------------

Your Responsibility and Duty of Care

- **Lodging an enquiry does not authorise project commencement.** Before starting work, you must obtain all necessary information from all affected asset owners.
- If you don't receive plans within 2 business days, contact the asset owner & quote their sequence number.
- Always follow the 5Ps of Safe Excavation (page 2), and locate assets before commencing work.
- Ensure you comply with State legislative requirements for Duty of Care and safe digging.
- If you damage an underground asset, you MUST advise the asset owner immediately.
- By using the BYDA service, you agree to the [Privacy Policy](#) and [Term of Use](#).
- For more information on safe digging practices, visit www.byda.com.au

Asset Owner Details

Below is a list of asset owners with underground infrastructure in and around your job site. It is your responsibility to identify the presence of these assets. Plans issued by Members are indicative only unless specified otherwise. Note: not all asset owners are registered with BYDA. You must contact asset owners not listed here directly.

Referral ID (Seq. no)	Authority Name	Phone	Status
263708352	APA Group Gas Networks (90073)	1800 085 628	NOTIFIED
263708350	Brisbane City Council	(07) 3403 8888	NOTIFIED
263708349	NBN Co Qld	1800 687 626	NOTIFIED
263708351	Queensland Urban Utilities	13 26 57	NOTIFIED
263708353	Telstra QLD South East	1800 653 935	NOTIFIED

END OF UTILITIES LIST



Plan

Plan your job. Use the BYDA service at least one day before your job is due to begin, and ensure you have the correct plans and information required to carry out a safe project.



Prepare

Prepare by communicating with asset owners if you need assistance. Look for clues onsite. Engage a skilled Locator.



Pothole

Potholing is physically sighting the asset by hand digging or hydro vacuum extraction.

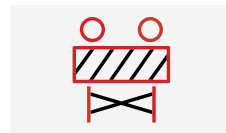

Protect

Protecting and supporting the exposed infrastructure is the responsibility of the excavator. Always erect safety barriers in areas of risk and enforce exclusion zones.



Proceed

Only proceed with your excavation work after planning, preparing, potholing (unless prohibited), and having protective measures in place.

Engage a skilled Locator

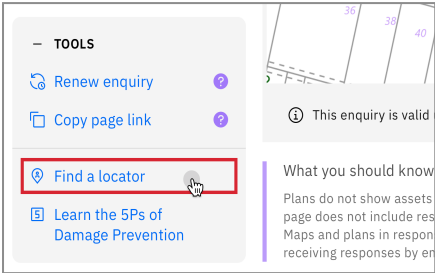

When you lodge an enquiry you will see skilled Locators to contact

Visit the Certified Locator website directly and search for a locator near you

certloc.com.au/locators

Get FREE Quotes for Contractors & Equipment Fast



Use iseekplant's FREE marketplace to get quotes for the equipment or services you need on your project. Compare quotes from trusted local contractors and get your project done on time and in budget.

1. Fill out your job details in our FREE quick quote form.
2. We send the request to trusted local contractors.
3. The local contractors will contact you directly with quotes

GET QUOTE

Use iseekplant to find trusted contractors near you today, visit: blog.iseekplant.com.au/byda-isp-get-quotes

Book a FREE BYDA Session



BYDA offers free training sessions to suit you and your organisation's needs covering safe work practices when working near essential infrastructure assets. The free sessions are offered in two different formats - online and face-to-face.

To book a session, visit: byda.com.au/contact/education-awareness-enquiry-form

BOOK NOW

Job ID 51611592

APA Group Gas Networks (90073)

Referral
263708352

Member Phone
1800 085 628

Responses from this member

Response received Wed 5 Nov 2025 11.55am

File name	Page
Response Body	5
263708352.pdf	6
400-STD-AM-0001_2 Guidelines for Works Near Existing Gas Assets.pdf	15

PLEASE NOTE: This is an automated response. Please **DO NOT REPLY to this email.** If you require further information in relation to this Before You Dig response, please contact

BYDA_APA@apa.com.au

Enquiry Details:

Impact	affected
Sequence Number	263708352
Enquirer Id	3748544
Activity	Planning and Design
Job Number	51611592
User Reference	24 Alkoomie St
Message	

Site Details:

Address	24 Alkoomie St Wynnum QLD 4178
---------	--------------------------------------

Enquirers Details:

Contact	Info Request HPC
Company	
Email	inforequest.hpc@harcourts.com.au
Phone	+61733974280
Address	15 Harries Road Coorparoo QLD 4151

APA Group

APA

Australia's energy
infrastructure partner



Before You Dig Australia

Classification: Networks

Enquiry date	05/11/2025
Sequence number	263708352
Work site address	24 Alkoomie St Wynnum QLD 4178



**For your immediate information****THERE IS A GAS PIPELINE OR INFRASTRUCTURE ASSETS
(GAS ASSETS)****located in close vicinity to your works.**

Enquiry Date: 05/11/2025
Enquirer: Info Request HPC
Sequence Number: 263708352
Work Site Address: 24 Alkoomie St
Wynnum
QLD 4178

Thank you for your Before You Dig enquiry regarding the location of gas assets.

We confirm there are Gas Assets located in close vicinity of the above location.

Caution: Damage to gas assets may result in explosion, fire and personal injury.

Please ensure you read all the relevant information contained in this response to your BYDA enquiry including reviewing the **APA Guidelines for Works Near Existing Gas Assets** and clearly understand and comply with all requirements relating to your scope of work.

If you have any queries relating to this information, or you are unable to comply with requirements of the APA Guidelines for Works Near Existing Gas Assets contact the APA Before You Dig Officer

- Phone 1800 085 628
- Email BYDA_APA@apa.com.au

for clarification before proceeding with any work.

Before You Dig Checklist



1. Plan

- Review maps provided with this BYDA response and confirm the location of your work site is correct.
 - Review the **APA Guidelines for Works Near Existing Gas Assets** and clearly understand requirements relating to my scope of work.
-



2. Prepare

- Electronically locate gas assets and mark locations.
 - Note: Look for visible evidence of gas assets at the worksite which may not be shown on plans.
-



3. Pothole

- Physically confirm ('prove') the location of gas assets by potholing by hand excavation or non- destructive vacuum excavation methods in accordance with **APA Guidelines for Works Near Existing Gas Assets**.
 - Road authorities, councils, utilities and their authorised contractors and agents are responsible to pothole or use other suitable methods to verify the location and depth of all gas assets, including gas (inlet) services, prior to commencing any works.
-



4. Protect

- Protect gas assets by maintaining clearances whilst excavating and following conditions provided by APA.
 - Where required by APA, only conducting work in proximity to gas assets while Site Watch is on site.
 - Where applicable, APA Authority To Work permit conditions are clearly understood and complied with.
 - Strap and support exposed mains and inlet services. Cover exposed mains to prevent damage until the excavation can be permanently restored.
-



5. Proceed

- Only proceed with your work once you have completed all the planning, preparation, potholing and protection requirements.
 - APA BYDA response (including maps) are on site for reference at all times, and less than 30 days old.
-

Contacts

Contacts APA Group	
Enquiry	Contact Numbers
General enquiries or feedback regarding this information or gas assets.	APA – Before You Dig Officer Phone: 1800 085 628 Email: BYDA_APA@apa.com.au
Gas Emergencies	Phone: 1800 GAS LEAK (1800 427 532)

Site Watch

Site Watch is where an APA field officer attends your work site to monitor and ensure controls are in place to protect critical gas assets from damage during work.

The following rates apply for this service (1 hour minimum charge):

Item	Rate (excl. gst)
Site Watch – Business Hours	\$143.42 per hour
Site Watch – After Hours	\$175.06 per hour
Cancellation Fee	\$286.84
<i>Fee applies where cancellations received after 12pm (midday), 1 business day prior to the booking.</i>	

Contact APA – Before You Dig officer for state specific hours of business.

Site 24 Alkoomie St
Address: Wynnum
QLD 4178

Sequence 263708352
Number:

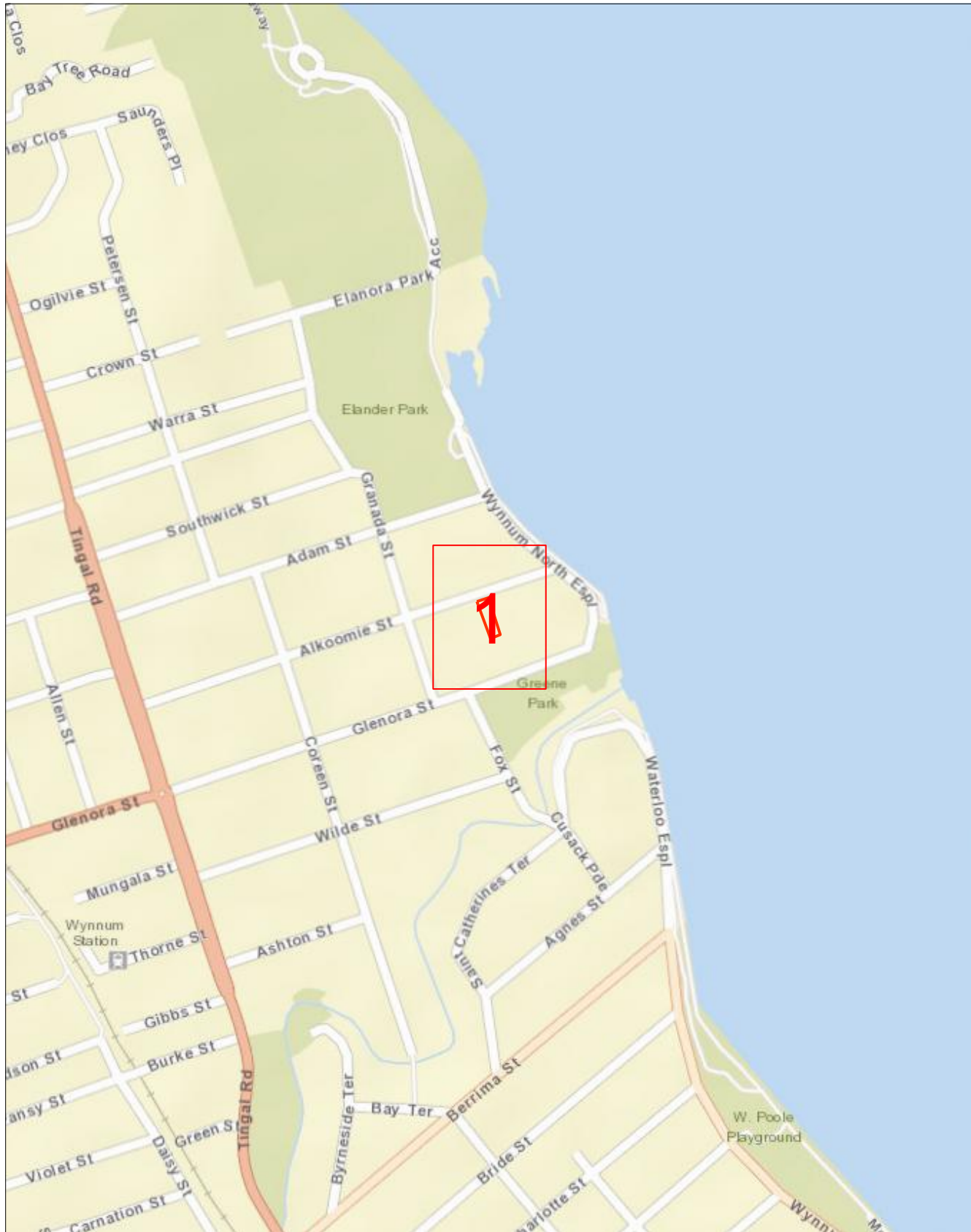

Scale 1: 6000

Map Sources: Esri, Garmin, HERE, FAO, NOAA, USGS,
© OpenStreetMap contributors, and the GIS User Community



Enquiry Area



Map Key Area



Site 24 Alkoomie St
Address: Wynnum
QLD 4178

Sequence 263708352
Number:



Scale 1: 700

Map Sources: Esri, Garmin, HERE, FAO, NOAA, USGS,
© OpenStreetMap contributors, and the GIS User Community



Enquiry Area



Map Key Area



Legend

<p>Pipe</p> <p>Low pressure </p> <p>Medium pressure </p> <p>High pressure </p> <p>Transmission pressure </p> <p>Critical main (behind pipe) </p> <p>Proposed (pressure by colour) </p> <p>LPG (pressure by colour) </p> <p>Hydrogen blended (pressure by colour) </p> <p>Abandoned </p> <p>Idle/inactive </p> <p>Sleeve </p> <p>Casing (behind pipe) </p>	<p>Pipe code and material</p> <p>C* (for example, C2) Cast iron</p> <p>CU Copper</p> <p>N2 Nylon</p> <p>P* Polyethylene (PE)</p> <p>P3 Polyvinyl chloride (PVC)</p> <p>P6, P7, P9-P12 Medium density PE</p> <p>P2, P4, P8 High density PE</p> <p>S* Steel</p> <p>W2 Wrought galv iron</p> <p>W3 PE coat wrought galv iron</p>	<p>Object</p> <p>Valve </p> <p>Buried valve </p> <p>Regulator </p> <p>Gas supplied = yes </p> <p>CP rectifier terminal </p> <p>CP test station </p> <p>CP anode </p> <p>CP bond wire </p> <p>Syphon </p> <p>Trace wire point </p>
<p>Area</p> <p>BYDA area of interest </p>	<p>Abbreviation</p> <p>BoK Back of kerb FoK Front of kerb</p> <p>C Depth of cover Galv Galvanized</p> <p>CP Cathodic protection NTI Not tied in</p>	
<p>Example</p>		
<p>Pipe</p> <p> 40P6 in 80C2 40 mm high pressure medium density poly in an 80 mm cast iron casing</p> <p> 63S8 63 mm medium pressure steel</p>	<p>Pipe code</p> <p>Pipe diameter in millimetres is shown before pipe code. 40P6 = 40 mm nominal diameter</p>	<p><i>This map was created in colour and should be printed in colour</i></p>

Important information

- Refer to requirements relating to construction, excavation and other work activities in the **APA Guidelines for Works Near Existing Gas Assets** document with this BYDA response.
- BYDA enquiries are valid for 30 days. If your works commence after 30 days from the date of this response a new enquiry is required to validate location information.
- For some BYDA enquiries, you may receive two (2) responses from APA. Please read both responses carefully as they relate to different assets.
- Gas (inlet) services connecting Gas Assets in the street to the gas meter on the property are not marked on the map. South Australia Only – if a meter box is installed on the property, a sketch of the gas service location may be found inside the gas meter box. APA does not guarantee the accuracy or completeness of these sketches.

Free Gas Pipeline Awareness Training and Information

PROFESSIONALS

APA offers online and in-person toolbox forums to support safe work near underground gas assets. Topics include distribution and transmission pipelines, the permit process, and gas emergencies, with content suited for companies of all sizes. A Continuing Professional Development certificate is available upon completion.

Scan the QR code to register for an online toolbox, or email damageprevention@apa.com.au to request an in-person presentation.

HOMEOWNERS

If you're working near your home's gas pipes stay safe and view APA's video guide '**Working Safely Near Gas Lines: A DIY Homeowner's Guide**' which offers simple tips to avoid damaging gas pipes.

Scan the QR code to view the video, or for more information email damageprevention@apa.com.au



Disclaimer and legal details

- This information is valid for 30 days from the date of this response.
- This information has been generated by an automated system based on the area highlighted in your BYDA request and has not been independently verified.
- Map location information is provided as AS5488-2022 Quality Level D, as such supplied location information is indicative only.
- Whilst APA has taken reasonable steps to ensure that the information supplied is accurate, the information is provided strictly on the condition that no assurance, representation, warranty or guarantee (express or implied) is given by APA in relation to the information (including without limitation quality, accuracy, reliability, completeness, currency, sustainability, or suitability for any particular purpose) except that the information has been disclosed in good faith.
- Any party who undertakes activities in the vicinity of APA operated assets has a legal duty of care that must be observed. This legal obligation requires all parties to adhere to a standard of reasonable care while performing any acts that could foreseeably harm these assets.



APA
Australia's energy
infrastructure partner



Guidelines for Works Near Existing Gas Assets

400-STD-AM-0001

Revision 2

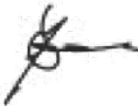
OWNER NAME:	Alan Creffield
OWNER TITLE:	Manager of Integrity
APPROVER NAME:	Anastasia Coutie
APPROVER TITLE:	Team Lead – 3 rd Party Engagement
APPROVAL SIGNATURE:	
APPROVAL DATE:	18/08/2023

always powering ahead



DOCUMENT CONTROL & APPROVAL INFORMATION

Summary of Changes

Below is a brief summary of the changes made to the document since the previous issued version.

Revision	Description	Date	Author
0.0	Issue for Use	29.06.2018	Matthew Read
1.0	Issued for Use – document periodic update / major overhaul	01.03.2022	Kahil Parsons
2.0	Removal of incorrect table 2 references to 1. proximity of HV cables 2. Updating separation distances to AS2885.3 BYDA reference update Table 4 Note	16.08.2023	Dale Russell

Printed Working Copy

All printed copies of this document are to be used as reference copies only.

It is the responsibility of those with printed copies to ensure that the document is current.

Responsibility

Any amendments to this document will be the responsibility of the document owner.

Control

Controlled Networks documents including templates are published on the Networks National Document Library (NNDL).

All native copies of published controlled Networks documents are managed by NetworksDocLibrary@apa.com.au in accordance with 400-PR-QM-0001, Networks Controlled Documents Development and Review procedure.



Table of Contents

DOCUMENT CONTROL & APPROVAL INFORMATION	2
Summary of Changes	2
Printed Working Copy	2
Responsibility	2
Control.....	2
TERMS OF USE	5
1 INTRODUCTION.....	6
1.1 Scope of this Document	6
1.2 Asset Types.....	6
1.2.1 Natural Gas Transmission	6
1.2.2 Natural Gas Distribution	7
1.2.3 LPG Distribution	7
1.3 Damage and Emergencies	7
1.4 General Duty of Care and Responsibility to Obtain Information	8
1.4.1 Additional Transmission Pressure Pipeline Requirements	8
2 PROTECTION PROCESS	9
2.1 Assessment Information	9
3 PART 1 - APA NOTIFICATION AND AUTHORISATION REQUIREMENTS	11
3.1 BYDA Request	11
3.2 Provings and Site Identification	11
3.3 APA Notification and Authorisation Process	11
3.4 Commercial Agreement and Service Delivery	13
3.5 Decommissioned Gas Assets	13
4 PART 2 - DESIGN AND ASSET PROTECTION REQUIREMENTS	15
4.1 Standard Clearances.....	15
4.2 Third Party Assets and Structures.....	19
4.3 Landscaping Plans	19
4.4 Surface Levels and Conditions.....	21
4.5 Casings Vent Stacks	22
4.6 Earthing and Electrical Effects	23
4.7 Temporary and Permanent Vehicle Crossings	24
5 PART 3 - CONSTRUCTION AND LAND USE REQUIREMENTS	25
5.1 Land Use Change.....	25
5.2 Permits and Site Watch.....	25
5.3 Coating Surveys and Leakage Surveys	26
5.4 Pipeline Repairs, Recoating and Slabbing.....	26
5.5 Exposure of Buried Gas Assets	27
5.5.1 General.....	27



Guidelines for Works Near Existing Gas Assets
400-STD-AM-0001 Revision 2

5.5.2	Physically Proving Gas Assets	27
5.5.3	Hydro-Vacuum Excavation	28
5.5.4	Mechanical Excavation	29
5.5.6	Protection During Exposure	30
5.5.7	Backfill and Reinstatement	31
5.6	Trenchless Excavation	31
5.7	Piles, Piers or Poles	32
5.8	Hot Works for Construction Activities	32
5.9	Vibration Limits	32
5.10	Compaction Limits	33
5.11	Blasting / Seismic Survey / Explosives.....	33
5.12	Suspended Materials above Gas Assets and No Go Zones for Cranes	34
5.13	Temporary Materials.....	34
6	PART 4 - ALTERATION OF EXISTING GAS ASSETS.....	34
7	GLOSSARY OF TERMS AND ABBREVIATIONS.....	35
8	DOCUMENT REFERENCES.....	40
APPENDIX A GENERAL BYDA RESPONSE PROCESS		41



TERMS OF USE

The “Guidelines for Works Near Existing Gas Assets Standard” is used for APA Networks excavations or third party excavations near APA Network operated assets. This guideline must only be used by the person or entity who received it directly from APA (“You”) to ensure the latest version is used.

APA Networks has provided this document to You subject to the terms of use set out below. By retaining possession of this document, You acknowledge and agree to the following conditions;

1. The information contained in this document relates only to APA Networks operated assets (as defined in this document) and does not relate to any other utility assets owned or operated by APA, such as APA Gas Transmission Pipelines.
2. This Guidelines document is provided to You to assist in the development of design plans, construction and land use activities.
3. This Guidelines document does not override or supersede APA’s Permit to Work (**PTW**) or Excavation policies and procedures.
4. Any proposed works in the vicinity of APA Networks operated assets may also require approval from other utility providers or government agencies. APA Networks has no responsibility for, and makes no representation in relation to, any requirements that may be necessary to obtain such approvals.
5. This document does not relieve any person from the requirement to make appropriate Before You Dig Australia (**BYDA**) enquiries, and otherwise discuss any proposed works with APA Networks, either for initial or subsequent works.
6. You must not reproduce this document without APA Networks permission and must not alter or amend this document.
7. To ensure the latest version of this document is used only APA Networks can provide a valid copy of this document.
8. APA Networks reserves its right to modify, amend, supplement, delete or withdraw any part of this document or any reference contained in this document, at any time without notice.
9. You must make your own independent enquiries in relation to any works that are proposed to be undertaken in the vicinity of any APA Networks operated assets (including obtaining all necessary express written consents and approvals from APA Networks). The information contained within is intended as a guide only.
10. Except as required by law and only to the extent so required, APA Networks and its related bodies corporate, officers, employees, agents and Contractors;
 - a) do not make any representation, warranty or undertaking, express or implied, as to, or accept any responsibility or liability for; and
 - b) are not in any way liable, directly or indirectly, to You or any other person for any loss, damages, costs, expenses or reliance arising out of or in connection with the validity, accuracy, completeness, relevance, or any errors in or omissions from, any information or statement contained in this document.
11. APA Networks reserves all its rights in the information contained in this document. No rights or obligations are granted or to be implied from the contents of this document. You acknowledge that all intellectual property and other tangible and intangible rights in the information contained in this document are and remain the exclusive property of APA Networks.
12. You agree to release and indemnify APA Networks and its related bodies corporate, officers, employees, agents and Contractors against all reasonably foreseeable claims, costs, expenses, losses and liabilities (including legal costs on a full indemnity basis) suffered or incurred by them as a result or in connection with the use of this document by You.

The purpose of this document is to provide guidelines for third parties planning to install new infrastructure or conduct works near existing APA Networks (**APA**) operated assets.

It is intended that this document will be provided to third parties proposing works around existing gas assets for their use during the design and planning phase following initial planning BYDA enquiries. This document does not provide authorisation to undertake the works but provides APA requirements to ensure that any review and acceptance of proposed works is completed as quickly as possible.

1 INTRODUCTION

1.1 Scope of this Document

This document addresses APA’s requirements for considering how a third party’s proposed works and APA managed works may impact APA Networks operated assets under the following parts:

Part 1 – APA Notification and Authorisation Requirements

Part 2 – Design and Asset Protection Requirements

Part 3 – Construction and Land Use Requirements

Part 4 – Alteration of Existing Gas Assets

APA Networks acts as the asset operator on behalf of entities Australian Gas Networks (**AGN**), Allgas, APA, Origin and Queensland Nitrates (**QNP**) and operates in New South Wales, Northern Territory, Queensland, South Australia and Victoria. The criteria provided in this document only applies to the assets managed by APA Networks on behalf of these companies.

APA also owns and operates natural gas transmission infrastructure on all mainland states and territories of Australia. These assets are operated by a separate APA entity and are out of scope for this document.

A glossary of all terms and abbreviations used in this document is contained in **Section 7**.

A list of all relevant external standards and APA reference documents is contained in **Section 8**.

1.2 Asset Types

APA Networks’ operated gas assets include buried pipe, above and below ground stations (e.g. pressure regulation, valves, meters), electrical cables, cathodic protection systems (e.g. test points, anode beds), pits and electrical cabinets. Depending on the gas type and the operating pressure, gas assets are classified as natural gas transmission, natural gas distribution and Liquefied Petroleum Gas (**LPG**) distribution as shown in **Figure 1**.

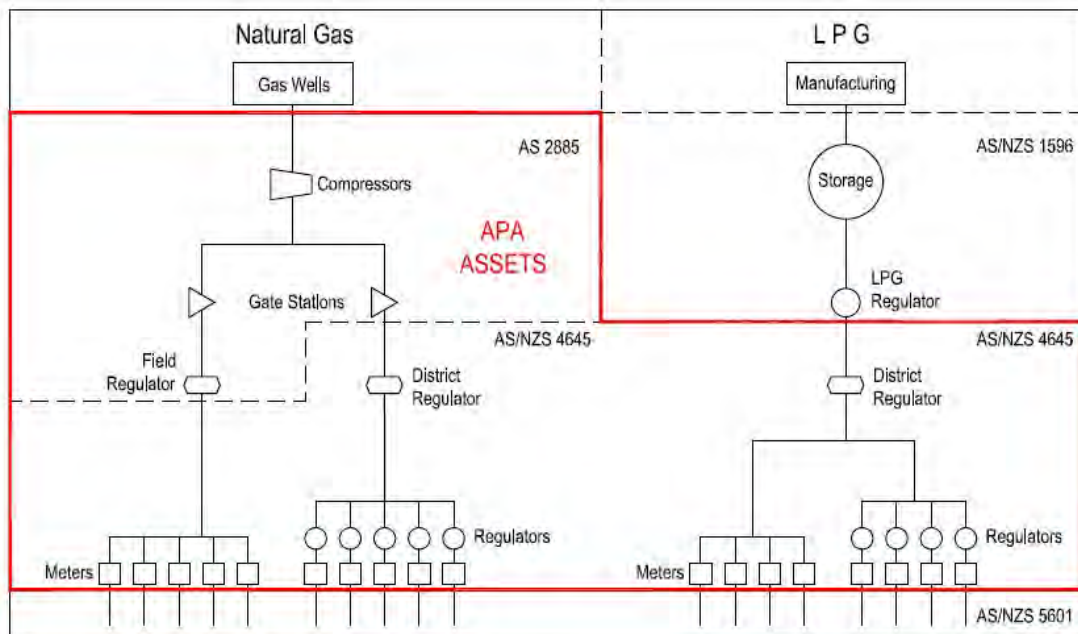

Figure 1 Asset Types and Standards Operated by APA Networks

1.2.1 Natural Gas Transmission

Natural gas transmission pressure assets operate at pressures above 1,050 kPag, and are generally used for transporting large quantities of gas across country. Design, construction and operation of these assets is governed by the AS 2885 suite of Australian Standards (**AS**).

Due to the higher pressure and energy density, there are severe safety, supply and environmental consequences which can result from third party interference. Hence, more stringent requirements and controls are applied to third party works in the vicinity of these assets.



Buried transmission pipelines are constructed from coated steel pipe where the appearance can vary depending on the year of construction, but will generally appear as yellow, black or grey when physically exposed.

1.2.2 Natural Gas Distribution

Natural gas distribution pressure assets operate at pressures below or equal to 1,050 kPag from offtakes of transmission pressure assets, and are generally used to supply consumers such as businesses and homes. Design, construction and operation of these assets is governed by the AS/NZS 4645 suite of Australian Standards.

Due to the lower energy density compared to transmission assets, less stringent requirements and controls are applied to distribution assets. Some distribution assets are deemed critical by APA Networks due to the safety and supply implications that may arise due to a third party strike. These critical distribution assets will be defined on BYDA responses, and some of the controls which are applied to transmission pressure assets (e.g. permit and site watch) will be required.

Buried distribution pressure pipes may be constructed from the following materials and physical appearances when exposed:

- Cast Iron (black);
- Polyethylene (PE) (yellow or black with yellow stripes);
- Steel coated or uncoated (generally yellow, black or grey); and
- Other plastic such as Polyvinyl Chloride (PVC) or nylon (yellow).

Some legacy materials such as cast iron and nylon may require additional protection during construction works due to the unpredictable nature of the materials.

1.2.3 LPG Distribution

LPG distribution pressure assets operate at pressures below 140 kPag from storage compounds and are generally used to supply consumers such as businesses and homes in parts of Queensland, South Australia and Northern Territory. Design, construction and operation of these assets is governed by the AS/NZS 4645 suite of Australian Standards.

Additional safety considerations are required in addition to the requirements for natural gas, as LPG is heavier than air and will pool at the leak point and can accumulate in a trench or excavation.

The same materials used for buried distribution pressure pipes (**Section 1.2.2**) may be used on LPG distribution networks.

1.3 Damage and Emergencies

If you smell gas or damage has occurred, or is suspected, on any gas asset call APA emergency number **1800 GAS LEAK (1800 427 532) or 1800 808 526 for LPG assets.**

Any unreported damage has the potential to escalate and endanger public safety.

Where damage has resulted in a release of gas, you are advised to take the following immediate action:

- Clear the area of all people. Do not under any circumstance re-enter the damage area;
- Where safe to do so, shut off or remove all ignition sources and devices in the area e.g. naked flames, vehicle engines, power tools, mobile phones;
- Do not attempt to stop the flow or repair the damage;
- Allow the gas to vent to air; and
- Once clear of the area, contact the emergency number **1800 427 532** or **1800 808 526 for LPG assets.**

The conditions in this document or as provided by APA Networks are intended to protect the gas assets as well as keep safe any construction crews or general public in the vicinity. Depending on the circumstances, some variation to the conditions in this document may be required or may be provided by an approved APA Networks site watch representative. It is legislated in all jurisdictions that the direction provided by APA is followed.



1.4 General Duty of Care and Responsibility to Obtain Information

Anybody working near a gas asset, or responsible for such work, has a duty of care to exercise caution, to maintain a safe working environment and to meet requirements of all relevant laws and Occupational Health and Safety legislation.

For general enquiries about results from BYDA please contact:

- DBYDNetworksAPA@apa.com.au for Northern Territory, South Australia, Southern New South Wales and Victoria, and;
- PermitsQLD@apa.com.au for Queensland and Northern NSW (incl. Tamworth).

The third party shall make contact with APA through the BYDA process if any clarification is required to determine the approval processes for any proposed land use changes (within the Measurement Length), design works and construction activities within 3 m of a gas asset or within a pipeline easement.

Any works proposed by the third party will only be authorised if APA is satisfied that the works will not affect the integrity of the APA Networks operated assets.

Any person undertaking work near an APA Networks operated asset, or responsible for such work, must ensure that they familiarise themselves with APA requirements.

Working around any gas asset, especially transmission pressure pipelines, without appropriate planning and controls as specified by APA Networks can be extremely dangerous. Damage to a gas asset could result in:

- Possible explosion and fire with the risk of loss of equipment, property, personal injury, and death;
- Loss of gas supply to thousands of customers;
- Substantial repair and gas restoration liability costs to the authority or principal responsible; and,
- Prosecution under the relevant laws governing pipeline and gas safety.

Prior to the commencement of any works within the Protected Zone of transmission pressure or critical gas assets, the Contractor performing the work must receive an Authority to Work Permit (ATWP).

Any works within the Protected Zone of critical assets must comply with any conditions attached to an ATWP and depending upon the nature of the asset and works supported by an approved construction methodology.

Written authorisation in the form of the ATWP must be kept on site at all times, and the holder of the authorisation must comply with all the conditions of the ATWP. The performance of any works near critical APA Networks operated assets without a valid ATWP and full compliance with its conditions will constitute a safety incident and may also result in an infringement notice and associated penalties issued by the regulator of the APA Networks asset.

1.4.1 Additional Transmission Pressure Pipeline Requirements

Where the works proposed by the third party may result in a change in land use within the Measurement Length for a transmission pressure pipeline (as defined in AS/NZS 2885.6 for Pipelines – Gas and Liquid Petroleum), such works may also be subject to formal approval requirements through APA Networks and applicable local and state government planning processes. This may also require a Safety Management Study (**SMS**) Report to be completed and approved by APA Networks. The SMS Report is generated from an SMS workshop involving an SMS facilitator, the third party and APA Networks. APA Networks is the owner of the SMS Report and any resulting recommendations/ actions must be implemented to the satisfaction of APA prior to the commencement of any physical works.

Certain categories of development/ land use change are not appropriate to be located within the Measurement Length of transmission pressure pipelines. In certain circumstances, the otherwise unacceptable risks associated with such developments may be alleviated with the aid of installing protective slabbing over the asset or undertaking other protection and mitigation measures.



2 PROTECTION PROCESS

APA is committed to working cooperatively with third parties to ensure that existing gas assets will be appropriately protected from any proposed works.

The process to be followed for any proposed works is outlined in **Table 1**. This table cross references the relevant section of this document which provides any specific requirements for each gas asset classification. The steps in this table are to be followed in conjunction with the process outlined by BYDA¹, a flow chart is also provided in **APPENDIX A**.

Table 1 Protection Process Summary

Section	Step	Purpose
3	Notification and Authorisation	<p>Identify and locate existing gas assets in the vicinity of any proposed works.</p> <p>Submit BYDA requests to obtain indicative plans of gas assets.</p> <p>Notify APA Networks and obtain approval to verify the exact position by physically proving the position of gas assets at the cost of the third party.</p>
4	Design and Protection Requirements	<p>Review APA Networks design and protection requirements for any proposed infrastructure near gas assets.</p> <p>If acceptable clearance is available in accordance with this section review impact of construction methodology on existing gas assets.</p> <p>If acceptable clearance is not available in accordance with this section and the proposed infrastructure cannot be modified, alteration or protection of the existing gas assets will be required at the cost of the third party.</p>
5	Construction and Land Use Requirements	<p>Review construction methodology for adverse impact to existing gas assets.</p> <p>Some additional protection measures may be required depending on the existing gas assets, the construction methodology and whether land use changes are required.</p> <p>If works meet the requirements of this document, submit work package to APA Networks for review and approval. If approval is given, then undertake works in accordance with APA Networks conditions/ permits. If approval is not given modify work package accordingly.</p> <p>If works do not meet the requirements of this document or APA Networks approval cannot be reached, alteration or protection of the existing gas assets will be required.</p>
6	Alteration	<p>Request alteration of existing gas infrastructure if there is insufficient clearance or construction methods will adversely impact existing gas assets.</p> <p>Alteration of existing gas assets are fully recoverable and may result in delays if not identified early.</p>

2.1 Assessment Information

Throughout the protection process, APA Networks assessment may be required to determine if the proposed works/ installation has sufficient separation or if work can be undertaken with a suitable construction methodology. If APA Networks assessment is required, the following information must be provided to enable an efficient and comprehensive review.

- Due dates or a work program;
- The location / address and extent of proposed works;

¹ BYDA process is available at <https://www.1100.com.au/safety-information/digging-safely/>

Guidelines for Works Near Existing Gas Assets
400-STD-AM-0001 Revision 2



- Scope / description of the work impacting APA assets;
- A work package containing detailed design or construction issue drawings with the location of APA assets and the extent of works marked and / or georeferenced. Sufficient details must be provided on the plans to verify locations against APA information, which is typically measured from property boundaries. Plan and cross sectional drawings are typically required, including any proving locations;
- The proposed construction methodology (if available); and
- For critical assets only, a completed permit request form. This form is automatically provided in response to a BYDA enquiry when it is required, with direction for this form included in the BYDA response (refer to **Section 5.2**).

If the information provided is incomplete, or irrelevant information is provided, it may result in a delay of the assessment process and provision of a response. Due to the varying nature of potential works, it is not possible to develop a comprehensive listing of information that will be required for each work type, but the above is provided as a general guideline for what will normally be required.



3 PART 1 - APA NOTIFICATION AND AUTHORISATION REQUIREMENTS

3.1 BYDA Request

The fastest method for obtaining APA Network gas asset locations is to lodge a BYDA request. A response can be expected from APA within two business days, and may include one of three responses as outlined in **APPENDIX A**, depending on the location of the works in relation to existing APA operated gas assets in the vicinity.

For some BYDA requests, APA Networks may provide different responses to different assets affected by the proposed works. In all instances it is the responsibility of the third party to review and follow the direction of all BYDA responses.

The information provided by APA Networks in response to a BYDA request, along with any other plans or subsequent information provided by APA, show only the indicative location of the asset at the time and are a guide only. In most instances it will be necessary to prove the location of all buried assets within the proposed work area.

The following items must be considered when using asset information provided by APA Networks:

- Gas service lines from buried distribution pressure supply mains to consumers may not be shown on plans. Service lines are usually laid at right angles from main to a meter position, except where road conduits are provided; and
- Plans become rapidly outdated and so should be used within 30 days and then destroyed. It is the responsibility of the third party to contact APA Networks to seek the updated or renewal of any information after this time.

APA shall not be liable or responsible for the accuracy of any information supplied.

3.2 Provings and Site Identification

Electronic location (e.g. ground penetrating radar, pipe locators) of gas assets is required to verify the onsite locations and any plans that have been provided.

Physical proving of existing gas assets is required at key locations to verify that the separation and protection criteria provided in this document have been achieved. The location and quantity of provings will depend on the scope of proposed work, but provings will at least be required at infrastructure crossing points or where changes to surface level condition are planned.

Additional verifications are required for works parallel and in close vicinity to existing gas assets. Physical provings at maximum 10 m intervals along straight sections of pipe, along with all bends, branch lines and customer service offtakes to verify asset locations.

Note: Live service offtakes which no longer supply consumers may protrude from the gas asset and are not traceable or identifiable from records.

Note: The maximum physical proving intervals for straight sections of pipe may be adjusted based upon the discretion of APA personnel for extenuating circumstances.

The following items must be considered when proving the location of an existing gas asset:

- Provings must be conducted safely and in accordance with the requirements of **Section 5.5.2**. If damage to a gas asset does occur it should be reported immediately to APA as described in **Section 1.3**.
- Permit and site watch by an APA Networks representative may be required for some proving activities in accordance with **Section 5.2**.

3.3 APA Notification and Authorisation Process

Prior to the third party undertaking any works/ activities or as part of the planning and design phase, the third party shall ensure a BYDA request is submitted. The automated response received from the BYDA system will be tailored based on the criticality of the assets.



For assets operated at distribution pressures and not considered critical mains, a Duty of Care Notice is provided with the BYDA response for the third party to consider. Site watch may be necessary under a duty of care notice where additional protection or other integrity concerns require it.

In the event that works are conducted within the Protected Zone of a transmission pipeline and/ or critical distribution main, these works will require a review approval received from APA prior to commencement of works. Works subject to this requirement are deemed to include, but not limited to, the following activities that fall under **Table 3**;

- Non Destructive Digging (**NDD**);
- Mechanical excavation including trenchless excavation i.e. drilling (boring, horizontal direction drilling (**HDD**), pipeline bursting and tunnelling) for installing infrastructure such as the following;
 - o Roadways, driveways, railways, pavements;
 - o Electrical equipment (cables, overhead transmission lines, telecommunication cable or power poles);
 - o Installation of culverts/ pipes (water, drainage, sewer or reticulation);
 - o Landscaping.

APA will not approve certain activities and structures in the transmission pipeline easement (if applicable), including the following;

- Permanent storage;
- Installation of billboard structures;
- Use and storage for explosives, flammables or corrosives;
- Blasting;
- Structures forming part of any house, house extensions, carports or entertainment areas;
- Dams and other manmade water features. Locations of dams off the pipeline easement/ protected zone must not create run off or drainage towards the pipeline easement;
- Chemically treated effluent coming in contact with the pipeline easement/ protected zone;
- Garbage, sand fill, refuse disposal;
- Airstrips.

The Third Party must submit an enquiry to APA at the earliest possible stage to allow sufficient time for assessment. Submissions should include the following information;

- Land description and map identifying location of the proposed works;
- Types of works to be carried out;
- Intended future use of the land (where relating to change in land use)
- Type and weight of machinery that will be used;
- Any plans or diagrams of the works;
- Timeframe for the works.

The sequence of obtaining APA approval is as follows;

- a) Submit enquiry for Initial Review – The Third Party submits the request prior to works commencing and APA Networks will complete an 'Initial Review'. The third party must not progress any works on site until they receive a response from APA Networks. The two possible outcomes of this stage are a 'No Impact' response or;
- b) Enquiry Escalated for Standard Assessment – The request will be forwarded to APA Networks Field or System Operations personnel for a more detailed appraisal, which may involve contacting the third party, site visits, locating of assets of site, and/or request for additional information. The third party must not progress any work on site until they receive a response from APA Networks. The two possible outcomes of this stage are a 'No Objection under standard conditions' response or;
- c) Enquiry Escalated for Engineering Assessment – The request has been forwarded to the Integrity Third Party Engagement team for additional appraisal and determination of specific conditions. The third party must not progress any works on site until they receive a response from APA Networks. The two possible outcomes of this stage are a 'No Objection under special conditions response' or;



- d) Enquiry Escalated for Alteration – The Integrity Third Party Engagement team triggers the alteration process for this enquiry. The third party will be contacted for additional information and must not progress any work on site until they receive a response from APA Networks.
- e) No Impact – The third party receives a ‘No Impact’ response and can proceed with the works under appropriate APA Networks requirements e.g. Duty of Care, Authority to Work Permit and/or Site Watch.
- f) No Objection Under Conditions – The third party will receive a No Objection under standard or special conditions response and can progress with the planning of the works under the conditions specified in the response and appropriate APA Networks requirements e.g. Duty of Care, Authority to Work Permit and/or Site Watch.

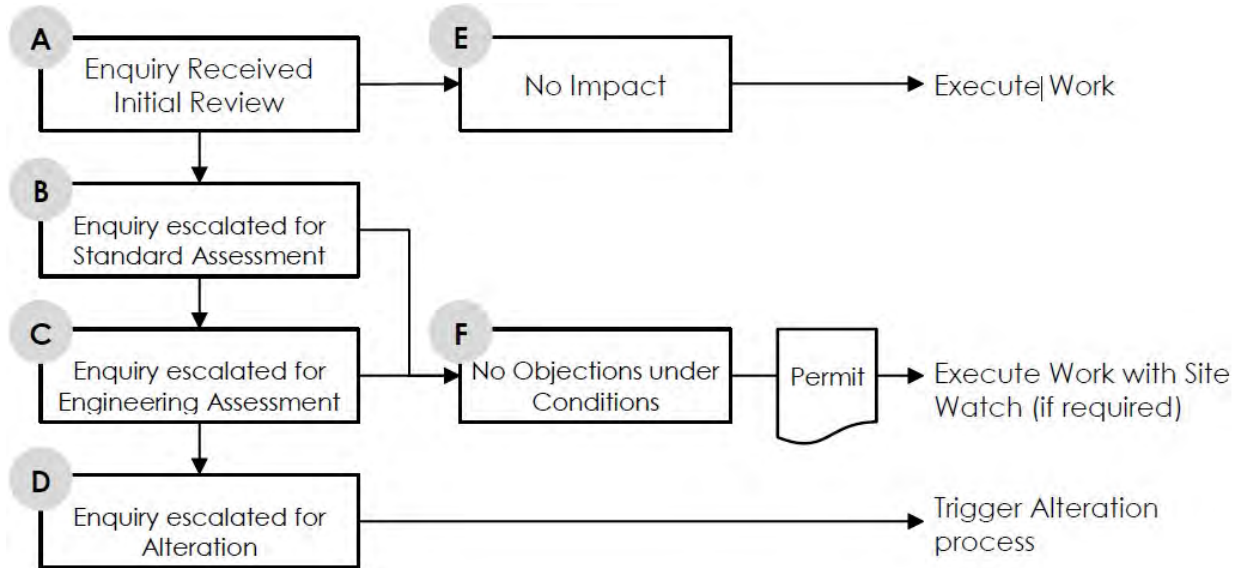

Figure 2 Stages for Third Party Works Authorisation Request

For works around APA Networks transmission pipelines or critical mains the documents take precedence in the following order;

- APA Authority to Work Permit (**ATWP**)
- APA accepted Third Party Construction Drawings
- APA accepted Third Party Construction Methodology
- APA Networks Guidelines for Works Near Existing Gas Assets (this document)
- APA accepted Third Party Safe Work Method Statement (**SWMS**) (if applicable)

3.4 Commercial Agreement and Service Delivery

APA will undertake a review of Third Party Works, as required. At APA’s discretion cost recovery for these works may be required. Where APA Networks requires cost recovery a commercial service agreement in the form of a Works Agreement will be required.

Note: Any third party works requiring blasting, seismic and/or tunnelling work near APA Networks operated assets will not be considered “low risk” and cost recovery for detailed review maybe required.

3.5 Decommissioned Gas Assets

Decommissioned gas assets that remain in the ground are not always shown on BYDA plans.

Where unknown assets are identified or suspected on site but are not on APA plans, they must be treated as being live. In this instance, the third party must contact all utility owners and operators in the area of the BYDA and notify them of the findings.

Following review, if APA accepts that it is a decommissioned gas asset, the asset must be treated as per the requirements of this document. APA will take no further action where it is not considered to be a decommissioned gas asset.

Guidelines for Works Near Existing Gas Assets
400-STD-AM-0001 Revision 2



In some cases, decommissioned gas assets are required for future use by APA (sometimes noted as “Idle” on APA plans). These assets must be treated as live using the same criteria outlined in this document, and must not be removed or altered without APA’s express written approval.

Where APA confirms there is no future use of a decommissioned gas asset (sometimes noted as “Abandoned” on APA plans), removal of the asset can be undertaken by the third party under the following conditions:

- For assets considered by APA to be decommissioned gas assets, APA must be engaged to verify that the asset is gas free;
- End caps must be permanently sealed, using an APA approved methodology, on any decommissioned sections that are to be left in place to prevent future water ingress into the remaining sections of the decommissioned gas asset;
- An as-built drawing must be submitted by the third party for any section(s) of a decommissioned gas asset removed by the third party or its sub-contractors to ensure BYDA can be updated accordingly; and
- Payment for costs associated with any verification or alteration activities must be provided prior to APA undertaking works.



4 PART 2 - DESIGN AND ASSET PROTECTION REQUIREMENTS

4.1 Standard Clearances

Minimum clearance dimensions outlined in this section must be met to allow for safe future maintainability and protection of existing gas assets. If separation clearances cannot be achieved, APA will review the proposed infrastructure on a case-by-case basis to determine whether a resolution can be achieved before alteration of any existing gas assets is considered. Authorisation of works by APA is still required, regardless of being able to achieve the required separation distances.

Clearances specified in **Table 2** are measured from the closest edges of the existing gas asset to the proposed infrastructure. Depending on the exact nature of proposed infrastructure, additional clearance may be required.

Note: Clearances specified herein are from gas assets, third party utilities may have their own standard separations that exceed APA’s minimums specified in **Table 2**.

The future access zone required around a gas asset depends upon a number of factors such as size, operating pressure, depth and soil conditions, but typically this access zone is at least 1000 mm either side and 700 mm below the gas asset. As an aid for design and / or installation, the minimum clearances presented in **Table 2** are provided to allow for safe future access to gas assets. These minimum clearances assume that the asset have been proven and the location verified. There may be circumstances where additional clearances are required.

Table 2 Minimum Clearances

Clearance Type (Note 2, 9)	Minimum Transmission Pressure Asset Clearance	Minimum Distribution Pressure Asset Clearance
Any installation up to 0.6 metres wide which is crossing the gas asset	500 mm Vertical (Note 2)	300 mm Vertical (Note 2)
Any installation over 0.6 metres wide which is crossing the gas asset	500 mm Vertical	300 mm Vertical (Note 2)
Any installation laid by trenchless excavation e.g. HDD, boring, etc.	3000 mm Vertical	600 mm Vertical
	Refer to Section 5.6 for minimum horizontal separation distances	
Any installation laid parallel to a steel gas asset	600 mm Horizontal (Note 2, 3)	
Any installation laid parallel to any gas asset other than steel	N/A	300 mm Horizontal (Note 2, 3)
Trenching separation from edge of gas asset to edge of trench (Note 4)	500 mm Horizontal	300 mm Horizontal
Underground electrical cables laid parallel to any gas asset other than steel	N/A	300 mm Horizontal
Electrical conduits and cables (<11 kV) laid parallel to a steel gas asset	Engineering assessment required (Note 2, 3)	
Electrical conduits and cables (≥ 11kV) laid parallel to a steel gas asset	(Note 2, 3) Engineering assessment required (Note 7)	



Electrical earthing systems near a steel gas asset	High Voltage: Engineering Assessment Required Low Voltage: 300 mm Horizontal (Note 7)	
Electrical earthing system near any gas asset other than steel	N/A	300 mm Horizontal
Clearance Type (Note 2, 9)	Minimum Transmission Pressure Asset Clearance	Minimum Distribution Pressure Asset Clearance
Undisturbed cover from the top of the gas asset to the underside of trenching or road pavement boxing	500 mm Vertical	300 mm Vertical (Note 1)
Distance from predominant building line	3000 mm Horizontal Where applicable outside pipeline easement	Refer to Section 4.2
Distance from Sensitive Use Locations (Refer Section 7 for Glossary of Terms and Abbreviations)	APA Engineering Assessment Required (Note 8)	N/A
Canopies longer than 15 m parallel to the edge of the gas asset	3000 mm Horizontal (Note 10)	Refer to Table 4 (Note 10)
Any installation that could add excessive loads to the gas asset or restrict access to the gas asset	3000 mm Horizontal (Note 2)	
Any installations that may need require underpinning were APA to expose the gas asset	3000 mm Horizontal	
Any temporary stake, e.g. star picket	300 mm Horizontal	
Electrical poles including street lighting and traffic signals	3000 mm Horizontal Where applicable outside pipeline easement	1000 mm (Note 3, 5, 6, 7)
Fence post, including road safety barriers	3000 mm Horizontal when installed per APA requirements	500 mm Horizontal when installed per APA requirements
Pile or pier	3000 mm Horizontal when installed per APA requirements	500 mm Horizontal when installed per APA requirements
Permanent Heavy Vehicle Loads (Greater than 4.5T)	Refer to Section 4.7 Temporary and Permanent Vehicle Loads	
Tree Root Barrier	3000 mm Horizontal	1000 mm Horizontal Refer to Section 4.3 Landscaping Plans
Separation distances for vegetation	Refer to Section 4.3 Landscaping Plans	



Note 1: For distribution main crossings, where the vertical separation distance is less than 300 mm physical protective slabbing, e.g. HDPE or concrete, shall be installed where the other utility is crossing beneath the APA pipeline/distribution main.

HDPE or concrete, shall be installed where the other utility is crossing above the APA pipeline/distribution main.

No protective slabbing is required for utility crossings greater than 500 mm separation.

Note 2: Structures and large utilities crossing APA Networks operated assets need to be self-supporting so that future repairs or maintenance of the asset can occur as per **Section 4.2 Third Party Assets and Structures**.

Note 3: Horizontal separation includes utility surface access pits, thrust blocks and/ or footings.

Note 4: Additional horizontal separation may be required depending on the extent of the planned works, local soil conditions and trench stability of the existing gas asset. This is particularly relevant where works occur within the angle of repose of the existing gas asset (e.g. parallel trenching that is deeper than the existing gas asset) and may result in undermining.

Note 5: In accordance with 'AS/NZS 4853 – Electrical hazards on metallic pipelines' without further information and APA engineering assessment, no electrical power poles for 66kV or above are permitted within the following separation distances of steel gas assets;

- If the power line has an Overhead Earth Wire (**OHEW**) – 15 m;
- If power line does not have an OHEW – 100 m;

Note 6: Where electrical poles (including street lighting and traffic signals) are proposed which place the gas asset within the no dig zone specified by the electrical authority either of the following shall occur;

- a) The poles shall be designed with deeper foundations to be self-supporting if the gas asset needs to be excavated. Or;
- b) For non-metallic assets relocated into a conduit that extends past the no dig zone.

Note 7: Clearance for electrical cables and earthing systems from steel gas assets must be reviewed in accordance with **Section 4.6 Earthing and Electrical Effects**. Electrical cables, substations and/or earthing systems installed in the vicinity of steel gas assets require an Earth Potential Risk (**EPR**) and Low Frequency Induction (**LFI**) assessment to AS/NZS 4853.

Note 8: Requires a setback distance to stay away from the Measurement Length (refer to **Table 14 Glossary of Terms and Abbreviations**). Alternatively, the setback distance may be reduced if protection slabbing is installed along the Sensitive Use Location where interaction with the Measurement Length occurs. This may also be limited to the development area subject to APA engineering assessment.

Note 9: Pipeline protection needs to be assessed and shown on the design plans with design clearances. This includes recoating, bridge slab or asset strike protection slab.

Note 10: Clearance may be dependent on demonstrating that there is sufficient continuous ventilation.



For construction and land use activities around gas assets the minimum horizontal clearances referenced in **Table 3** must be followed.

Table 3 Minimum Clearances for Construction Works and Land Use Activities

Construction and Land Use Activities	Minimum Horizontal Clearance	
	Transmission Pressure & Critical Distribution Mains	Non-Critical Distribution Pressure Mains
Excavation without APA representative present (Note 1)	3000 mm	N/A
Trenchless Excavation (Note 1)	3000 mm Refer to Section 5.6	1000 mm Refer to Section 5.6
Temporary Heavy Vehicle Traffic (greater than 4.5T)	If the load has not been assessed, maintain a Horizontal separation of 3000 mm. APA engineering assessment must be completed if crossing asset. Refer to Section 4.7 Temporary and Permanent Vehicle Crossings	Refer to Section 4.7 Temporary and Permanent Vehicle Crossings
Installation of Piles, Piers or Poles	Refer to Table 2 and Section 5.7	
Hot Works from Construction Activities	Any hot works within 5000 mm of an open trench containing gas asset or where cover is less than 300 mm. Refer to Section 5.8. (Note 2)	
Compaction	Section 5.10 for Compaction Limits Maximum Compaction Limits	
Vibration Limits	No vibration within 3000 mm of the pipeline and greater distance to comply with Section 5.9	
Blasting, Seismic Survey or the use of Explosives	Approval required for works within 100m. Refer to Section 5.11 .	
Lifting over exposed gas asset	Not permitted over the gas asset. Refer to Section 5.12 for Suspended Materials above Gas Assets and No Go Zones for Cranes.	
Clearance of crane outriggers to gas assets	Not permitted within 3000 mm of gas asset. Refer to Section 5.12 for Suspended Materials above Gas Assets and No Go Zones for Cranes.	
Clearance of temporary material from pipeline	Not permitted within 3000 mm of gas assets. Refer to Section 5.13 for Temporary Materials.	

Note 1: Excavation covers NDD, mechanical excavation and trenchless excavation (boring, HDD, pipeline bursting and tunnelling).

Note 2: Horizontal separation distance also applies to any pits or valve covers.



4.2 Third Party Assets and Structures

Structures, including but not limited to buildings, walls, canopies, footings, pile caps or retaining walls, must not transfer any load to or be installed over any gas asset.

The design of any third party asset or structure must take into account future safe access of any gas assets in the vicinity. The proposed third party asset or structure must be installed in a way that prevents the angle of repose from encroaching into the future access zone as specified in **Section 4.1** around the existing gas asset.

Any third party asset or structure installed within proximity to a transmission pipeline or critical distribution pressure main must be designed to be self-supporting and allow for a minimum excavation window 1m on either side of the asset and 700 mm below the edge of the asset, for maintenance of the asset. This self-supporting design information is required to be shown on the construction drawings supported by geotechnical data and calculations. Construction of structures on pipeline easements are not permitted without explicit consent from APA.

Distribution pressure gas mains must be offset from the expected predominant building line at a distance in accordance with **Table 4**. Transmission pressure gas assets shall be per **Table 2**.

Table 4 Minimum Building Offset Distances for Distribution Pressure Gas Mains

Diameter (DN)	MAOP (kPag)			
	≤210	>210 ≤ 420	>420 ≤ 600	>600
≤110	0.5 m	0.5 m	1.0m	3 m
>110 ≤ 160	0.5 m	0.5 m	3 m	5 m
>160	0.5 m	3 m	3 m	8 m

Gas assets may be located underneath curbing or strip footings for road safety barriers for short sections up to 10 m to allow for tapers. The integrity of the gas asset to be located underneath the curbing or strip footing may require inspection, repair, recoating and / or slabbing depending on the existing condition and extent of proposed works.

Posts or poles which are located in road reserve, or otherwise exposed to vehicle impact, must be designed such that there will be no damage to the gas asset in the event of a vehicle impact.

For works in Victoria, consent from the relevant State Minister is required under Section 120 of the *Pipelines Act 2005* (VIC) for the erection of structures or buildings within 3,000 mm of a transmission pressure asset. Ministerial consent must be arranged through Energy Safe Victoria (**ESV**) following review and acceptance of the proposed designs by APA Networks.

4.3 Landscaping Plans

Vegetation may limit line of site, access and passage along an existing gas asset alignment, while the associated roots may damage existing buried pipe, coating or other ancillary equipment (e.g. cables). Above ground gas infrastructure may also be exposed to hazards from falling vegetation and increased fire risk. Additionally, trees and tree roots may limit access to the gas asset in an emergency, during normal operations and when make new connections or modifications.

Landscaping plans which include vegetation should select tree species which do not have vigorous root activity and do not exceed above 5m in height when fully mature when planted within 3m of gas assets. The pre-selection of trees considered suitable for planting within road reserves and near gas assets should also consider interference with, or damage to, other underground and overhead services.

For all landscaping works within 3 m of transmission pressure or critical distribution pressure gas assets the following details must submitted to APA for review and approval prior to planting.

- Tree species – botanical and common name
- Mature tree buttress and canopy diameter
- Mature tree height



- Maximum root ball diameter
- Offset from gas asset
- Method of protection to gas asset

Trees to be planted within 3 m of transmission pressure or critical distribution pressure gas assets, should also adhere to **Table 5** below.

Note: Horizontal separation is measured from pipe edge to edge of mature trunk or mature drip line, whichever is the greater.

Strata cells are not considered an appropriate protection from tree roots. If strata cells are to be installed in the vicinity of existing buried gas assets, the controls identified in **Table 5** must be used for protection.

Table 5 Protection of Distribution Gas Assets from Vegetation

Vegetation Types	Requirements	Horizontal Separation from Pipe Edge to Vegetation			
		Greater than 3 m	1.5 to 3m	1.5 to 0.5 m	<0.5 m
Trees or Large Shrubs	Min. separation of 3 m is required between trees and pipe if no protection methods are utilised.				
Medium and Small Shrubs	Within 1.5 m – 0.5 m protection methods must be utilised.				
Ground cover and grasses	No protection methods required.				
Gas Protection Methods					
	No protection methods required, provided separation limits are followed.				
	Within 3 m, tree species which have mature buttress diameters less than 0.15 m and do not have invasive or deep roots may be accommodated without protection methods after consultation with APA Networks (Note 1). For trees with mature buttress diameters greater than 0.15 m one of the following gas protection methods must be implemented; <ol style="list-style-type: none"> 1. Lowering or relocation of the gas asset to a minimum of 1.2 m cover. 2. Installation of new gas conduit beyond the structural root zone (SRZ) of the mature tree species for future use. (Note 2) 3. Installation of a root barrier system. System to be 1 m deep or extend 250mm below the gas asset, whichever is the greater. 				
	Within 1.5 m installation of a root barriers system is mandatory and gas protection methods are as follows; <ol style="list-style-type: none"> 1. Installation of a robust root barrier system. System to be 1 m deep or extend 250 mm below the gas asset, whichever is the greater. AND <ol style="list-style-type: none"> 2. Lowering or relocation of the gas asset to a minimum of 1.2 m cover. OR <ol style="list-style-type: none"> 3. Installation of new gas conduit beyond the SRZ of the mature tree species for future use. (Note 2) 				
	Planting directly over gas assets is not permitted in any location, as it prevents emergency and maintenance access. Tree roots can damage gas asset resulting in gas leaks.				



Note 1: Refers to the minimum 1.5 m structural root zone for a mature buttress diameter less than 0.15 m mandated under AS 4970 – Protection of trees on development sites.

Note 2: Suitable protection method for PE mains only. Conduits to be recorded in Geographic Information System (GIS) for future referencing.

Note 3: On transmission pressure assets vegetation must not limit line of site along the buried gas assets alignment, all signage must remain each in sight of the other.

4.4 Surface Levels and Conditions

Decreases or increases to surface levels must consider depth of cover requirements for gas assets specified in **Table 6**. This is in addition to maintaining a minimum working cover from the top of the gas asset to the underside of trenching or road box out works during construction as specified in **Table 2**. Vehicles must not cross gas assets at covers less than those specified in **Table 6** unless in accordance with **Section 5.10** for Compaction Limits or **Section 4.7** for Temporary and Permanent Vehicle Crossings.

Where existing surfaces are to be modified, finished cover levels are not to be reduced to less than existing levels, unless meeting the minimum requirements of **Table 6**. The requirement for, and the extent of, protective slabbing over any APA Networks operated asset will be determined by APA at its sole discretion with adherence to minimum depth of cover without physical protection as the preference. Depending on the location, local councils and relevant road/ rail authorities may have minimum depth of cover requirements that APA are required to meet which are more stringent than those listed in **Table 6**. Depth of cover requirements for individual consumer offtakes (service connections) are also provided in **Table 7**.

Details of any additional fill proposed to be placed on or within 3 metres of a gas asset, or within any applicable easement, must be clearly shown on plans and must be approved by APA Networks in writing. A maximum depth of cover of 2,500 mm for transmission pressure assets and 2000 mm for distribution assets apply in all locations; however, it is preferred not to exceed 1500 mm for both types of assets.

Table 6 Minimum Depth of Cover Requirements for Pipelines and Mains

Asset Location	Minimum Depth of Cover (Note 3)	
	Transmission Pressure Asset	Distribution Pressure Asset
Under Minor Road Pavement (Note 1)	<ul style="list-style-type: none"> • 1,200 mm • 1,200 mm to 1,000 mm with physical protection slabbing and APA engineering load assessment 	<ul style="list-style-type: none"> • 750 mm • 750 mm to 600 mm with physical protection slabbing and APA engineering load assessment
Under Major Road Pavement (Note 2)	<ul style="list-style-type: none"> • 1,200 mm • 1200 mm to 1,000 mm with bridging slabs (Note 4) 	<ul style="list-style-type: none"> • 1,200 mm • 1200 mm to 750 mm with bridging slabs (Note 4)
In Road Reserve but not Under Road Pavement	<ul style="list-style-type: none"> • 900 mm • 900 mm to 750 mm with protective slabbing contingent upon pipeline location class 	<ul style="list-style-type: none"> • 750 mm • 750 mm to 600 mm with protective slabbing
Not in Road Reserve	<ul style="list-style-type: none"> • 900 mm • 750 mm with protective slabbing contingent upon pipeline location class 	<ul style="list-style-type: none"> • 750 mm for > 210 kPa • 600 mm for ≤ 210 kPa
Railway Reserve	2000 mm (Note 5)	
Large Open Drain or Major Water Crossing	2000 mm (Note 6)	



Note 1: Minor road pavements typically are owned by local councils.

Note 2: All roads owned by state and federal authorities are major roads. Roads owned by council may be major or minor roads. Covers less than 1200 mm may require dispensation from the relevant road authority.

Note 3: Protective slabbing must be installed where minimum depth of cover requirements cannot be met or are required to meet specific safety requirements. Bridging slabbing for transmission pressure assets may be replaced with protection slabbing following APA engineering assessment.

Note 4: The requirement for bridging slabs can be downgrade to physical protection slabbing where APA engineering assessment is completed and approved.

Note 5: Installation within railway reserve shall be in accordance with both AS 4799 and the respective operating standard for the gas assets i.e. AS 2885 and AS 4645.

Note 6: The minimum depth of cover of 2,000 mm shall consider future scour of the drain or waterway crossing. For man-made drains the depth of cover can be reduced to 1200 mm if sealed (i.e. concreted) and appropriately designed. For transmission pressure assets, waterway crossings shall be designed in accordance with AS 2885.1 – 2018 Clause 5.8.6.2. For all assets, as a minimum the following shall be considered;

- a) A hydrological investigation to determine the stream power under peak stream, watercourse or waterway flows. The investigation shall determine the 1 in 100 year flood and the probable maximum flood and intermediate (optional) flood conditions.
- b) A geotechnical investigation to determine the physical parameters of the crossings, and using the information from the hydrological investigation, the erosion potential. This assessment should also consider the meander potential of the watercourse so that the limits of special construction can be defined.

Table 7 Minimum Depth of Cover Requirements for Customer Offtakes (Services)

Asset Location	Customer Offtake size	
	≤ DN50	> DN50 and ≤ DN110 (Note 1)
Roadway	450 mm	600 mm
Private Property	300 mm	450 mm

Note 1: Customer offtakes (services) with diameters greater than DN110 shall have depth of cover in accordance with **Table 6**.

Changes to surface conditions (e.g. changing from nature strip to road pavement) or which place the gas asset in an inaccessible position (e.g. with excessive cover) may require slabbing, recoating and / or relocation. Changes to surrounding surface levels or conditions must also consider drainage and the potential to result in erosion of cover for gas assets. Additionally, gas fittings such as valves, stopple fittings or flanges must not be located underneath road pavement. An APA Engineering assessment will be required if this is not feasible, refer to **Section 6**.

Where a new hardstand surface is installed on non-metallic distribution pressure mains (e.g. a painted concrete driveway), consideration should be given to including a casing or enveloper pipe to APA requirements for insertion of future gas assets. This will ensure that the new hardstand surface is not modified as part of the future gas installation. Where a casing or enveloper pipe is installed for future insertion works surveyed as-constructed records are to be provided to APA Networks for incorporation into the GIS records.

For transmission pressure gas assets, any landscaping material should be level within the easement or a minimum of 3 m (but preferably 6 m) to each side of the pipeline, to permit excavating equipment to operate without having to destroy the adjacent landscaping.

4.5 Casings Vent Stacks

Casings provide mechanical protection and protection to gas assets from external loadings. Some cased crossings are sealed and fitted with a casing vent stack, which gas leaks are identified via.

The following APA requirements are to be applied for works near casing vent stacks:



- Casing vent stacks cannot be removed unless an alternative arrangement has been approved by APA Networks or they have been assessed as being redundant;
- Unfettered access is to be maintained to casing vent stacks; and
- Minimum distance from casing vent stack discharge point to any electrical installation or overhead structure must be 1000 mm.

4.6 Earthing and Electrical Effects

Steel gas assets are susceptible to adverse effects from electrical sources such as above and below ground cables, substations, transformers, earth rods, cathodic protection systems or electrified tram / train lines.

Without any further information or engineering assessment, earthing systems for distribution ($\geq 11\text{kV}$) and transmission ($\geq 66\text{kV}$) power lines must satisfy the Earth Potential Rise (EPR) Level 1 (Conservative) compliance of AS/NZS 4853 – 2012 Table 4.3 & 4.5 which specifies separation distances from pipe appurtenances (e.g. valves, regulators, isolation joints), access points or earth points (including cathodic protection test points). For the potential hazards to be accepted as low risk on the basis of a Level 1 assessment the separation between a conductive structure or substation and pipeline subject to EPR shall be greater than the values given in **Table 8** below.

Table 8 Separation Distances for Pipeline Subject to EPR from Power Lines (Level 1 Assessment)

Fault Current or Actual Current (A) (Note 2, 3)	Separation Required (m) - Note 1				
	Distribution ($\geq 11\text{kV}$)	Power Line	Transmission ($\geq 66\text{kV}$)	Power Line	
	100 $\Omega\cdot\text{m}$	500 $\Omega\cdot\text{m}$	100 $\Omega\cdot\text{m}$	500 $\Omega\cdot\text{m}$	
150	40	190	N/A	N/A	
300	80	390	N/A	N/A	
500	130	660	N/A	N/A	
750	200	1,000	N/A	N/A	
1,000	270	1,300	60	310	
3,000	N/A	N/A	190	940	
6,000	N/A	N/A	380	1,900	
10,000	N/A	N/A	635	>3,500	

Note 1: Earth resistivity of 500 $\Omega\cdot\text{m}$ shall be used for dry sand or rock and 100 $\Omega\cdot\text{m}$ for all other cases.

Note 2: If the fault current is unknown for a distribution power line ($\geq 11\text{kV}$), a fault current of 1000 A shall be used for the first pass assessment.

Note 3: If the transmission power line ($\geq 66\text{kV}$) uses an OHEW, uses values up to 3,000 A (this assumes a current split of 30% of 10 kA). For lines without an OHEW, use values up to 10,000 A for current going down the structure.



Without any further information or engineering assessment, distribution (≥ 11 kV) and transmission (≥ 66 kV) power lines parallel to steel gas assets must satisfy the Low Frequency Induction (LFI) Level 1 (Conservative) compliance of AS/NZS 4853 – 2012 Table 4.2 & 4.4 which specifies maximum acceptable power line to pipeline exposure length.

Per AS/NZS 4853 – 2012 the pipeline expose length (average separation for the parallel section) under LFI conditions shall be less than the values given in **Table 9** below.

Table 9 Exposure Length for Pipeline Subject to LFI from Power Lines (Level 1 Assessment)

Power line to pipeline separation (m)	Exposure Length (m) – Note 1	
	Distribution Power Line (≥ 11 kV) – 100 Ω .m	Transmission Power Line (≥ 66 kV) – 100 Ω .m
5	180	95
10	210	110
20	240	127
50	310	165
100	400	210
200	550	290
500	950	500

Note 1: Without soil resistivity data, assessments are to be completed assuming 100 Ω .m. If soil resistivity data is available refer to AS/NZS 4853 – 2012.

Where AS/NZS 4853 Level 1 EPR or LFI requirements cannot be achieved a Level 2 and/or 3 assessment will be required.

The third party must provide to APA detailed plans of any source(s) of earthing and/ or electrical effects proposed to be located in the vicinity of steel gas assets, with an assessment report compliant with AS/NZS 4853 Electrical Hazards on Metallic Pipelines. This assessment report is to determine any effects to existing cathodic protection or induced voltage mitigation systems from these types of installations. The third party must address any relevant requirements and any recommendations and/or actions must be implemented to the satisfaction of APA Networks. All cost association with the study, and implementing its recommendations and/ or actions are to be borne by the third party. The third party must also complete validation testing upon completion of construction and provide all findings/ reports to APA Networks.

Hazards which may arise due to electrical systems located in the vicinity of steel gas assets include the following:

- Accidental contact between gas assets and electrical systems;
- Capacitive coupling;
- Conductive coupling;
- Electromagnetic induction;
- Low Frequency Induction (LFI);
- Earth Potential Rise (EPR), including due to fault current or lightning discharge; and,
- Adverse cathodic protection interference in excess of those allowed under AS 2832.1 or relevant state regulations

4.7 Temporary and Permanent Vehicle Crossings

Vehicle crossings over existing gas assets are limited to light vehicles (Gross Vehicle Mass not greater than 4.5 tonnes unless advised otherwise by APA Networks in writing) on unsealed surfaces or Heavy Vehicles (compliant General Access Vehicles) on established road pavements.

Any proposed new crossings must be assessed and authorised in writing by APA Networks.



A maximum surface pressure of 400 kPa is allowable directly above buried gas assets. However, any surface pressure exceeding this limit or where cover over the gas asset has been reduced from **Table 6** will require an APA Engineering Assessment and approval.

Where soil conditions exhibit poor compaction and load bearing characteristics, such as wet soil conditions, equipment is not permitted to cross the gas asset irrespective of weight without establishing a stable sealed surface or road plates.

Crane footings or bog mats must not be placed where the angle of repose can influence an existing gas asset without express written approval by APA. Where the existing gas asset is within the angle of response, the maximum surface pressure due to the crane must be provided.

5 PART 3 - CONSTRUCTION AND LAND USE REQUIREMENTS

Extreme care should be exercised at all times when working around existing gas assets, as repair works will be fully chargeable and may result in delays to any works. Refer to the duty of care outlined in **Section 1.4** and the requirements of this section when selecting construction methods.

5.1 Land Use Change

Where works proposed by a third party may result in a change in land use within the Measurement Length (as defined in AS/NZS 2885.6 for Pipelines – Gas and Liquid Petroleum) of transmission assets, such works may also be subject to formal approval requirements through APA Networks and applicable local and state government planning processes.

This may also require a Safety Management Study (SMS) report be completed and approved by APA Networks. This SMS report is generated from an SMS workshop involving an independent SMS facilitator, third party and APA Networks. APA Networks is the owner of the SMS report and any resulting recommendation/ actions must be implemented to the satisfaction of APA Networks prior to the commencement of any physical works.

Certain categories of development, such as Sensitive Use Locations (refer to **Table 14 Glossary of Terms and Abbreviations**), are not appropriate to be located with the Measurement Length. In certain circumstances, the otherwise unacceptable risks associated with such developments may be alleviated with the aid of installing protective slabbing over the transmission pipeline or undertaking other protection and mitigation measures.

Sensitive Use Locations near transmission pipelines are designated under AS/NZS 2885.6 and identify land where the consequences of a Failure Event may be increased because it is developed for use by sectors of the community who may be unable to protect themselves from the consequences of a pipeline Failure Event.

Sensitive uses are defined as follows;

- Schools, which includes colleges
- Hospitals and aged care facilities such as nursing homes, elderly people's homes
- Prisons and jails
- Sheltered housing
- Buildings with five or more stories
- Large community and leisure facilities, large open air gatherings
- Day care facilities
- Other potentially difficult to evacuate facilities
- Other structures as defined by relevant local councils.

For further information regarding the SMS process, refer to APA Networks Encroachment and Land Use Change SMS Trigger Procedure, **400-PR-L-0003**.

5.2 Permits and Site Watch

Transmission pressure assets and critical distribution pressure assets, must have a permit issued prior to proposed works in the vicinity of the existing assets, including any proving activities. Following the issue of a permit, a site watch inspector may be required to verify that the activities are carried out appropriately.



Other distribution pressure assets not considered critical will only require site watch as determined by APA Networks.

Where a permit is required, the response provided to the BYDA enquiry will include the relevant forms and process to be followed for submitting a permit request.

While BYDA recommends completing the request two business days prior to undertaking works, this is to ensure that the location information is obtained. This may not allow sufficient time for APA Networks to supply site watch. Further delays may be experienced if the proposed works are significantly complicated, do not meet the requirements of this document or if insufficient information is provided.

It is an offence in all jurisdictions to undertake activities in the vicinity of transmission pipelines without prior authorisation by the operator.

5.3 Coating Surveys and Leakage Surveys

Where proposed works have potential to indirectly damage pipe coating (i.e. due to compaction) or result in a leak of the gas asset (e.g. vibration of cast iron pipes), additional monitoring activities such as Direct Current Voltage Gradient (DCVG) or leakage surveys may be required.

If required, chargeable DCVG surveys will be conducted prior to works to establish any existing coating faults which exist on the gas asset. A subsequent DCVG survey will be conducted at the conclusion of works, and where new faults have developed on the gas asset, repairs shall be made with costs charged to the works owner. Surveys can be conducted prior to finalising road surfaces to avoid costly repairs.

A similar chargeable survey program can be applied where leakage surveys are required. However, additional surveys may be necessary throughout works to ensure work crews do not operate in a gaseous environment once leaks are caused.

5.4 Pipeline Repairs, Recoating and Slabbing

Buried steel assets operated by APA Networks are coated to provide protection from corrosion.

Where the surface conditions above a buried steel pipe are changed which may limit future access to the existing gas asset an assessment of the coating condition will likely be triggered.

The requirement for pipeline recoating is assessed by APA Networks on a case by case basis, based on the proposed works, but will generally be dependent on the following:

- The asset class;
- The existing coating type, age and condition;
- Increase in loading that can bring forward any pipeline anomalies; and,
- Changes limiting access to the existing asset(s), such as the installation of slabbing, road pavement, culverts, embankment ramps or any other feature.

A chargeable coating survey carried out in accordance with **Section 5.3** may be required to assess the condition of the existing gas asset coating.

Recoating and/ or associated slabbing works over any gas asset will be determined by APA Networks Engineering Assessments and any applicable risk assessments (Safety Management Study or Formal Safety Assessment).

Pipeline repairs, recoating and slabbing that form part of any third party commercial agreement will be charged to the third party.

The requirement for, and the extent of, slabbing over any APA Networks operated asset will be determined by APA at its sole discretion and may depend on factors other than only changes in depth of cover discussed in **Section 4.4**. Slabbing may be required for the following reasons:

- Removable protective slab to provide protection from third party mechanical excavation;
- Bridging slab to provide protection from external loadings e.g. insufficient depth of cover combined with vehicle traffic.

Slabbing must be installed with adequate separation from the pipe, which may impact the undisturbed cover requirement, and cannot be installed directly underneath road pavement or at surface level.



Any bridging slab designs prepared by a third party must be accompanied by certification from the registered practising structural engineer (Registered Professional Engineer Queensland (**RPEQ**) required for works in Queensland, and so on as required for other States and Territories) confirming that the design is adequate to prevent pipeline loading.

5.5 Exposure of Buried Gas Assets

5.5.1 General

Excavation works covers Non-Destructive Digging (**NDD**) and mechanical excavation. All such excavations must be completed in accordance with APA's direction.

The Third Party or its Contractor can perform exposure works on APA Networks operated assets via NDD using vacuum excavation and subsequent mechanical excavation works under the following conditions:

- **A current BYDA request is available for the works.**
- An approved Authority to Work Permit (**ATWP**) is issued for works near transmission pipelines or critical mains.
- APA Site Watch Officer is present for works near transmission pipelines or critical mains as outlined on the ATWP.
- The Third Party (or its Contractor) shall ensure they have their own SWMS, Risk Assessment, Environmental Management Plan, Tool Box Talk, Traffic Management and Pre-Start in line with their own corporate policy in place prior to works commencing.
- All underground assets have been identified by surface marking where within or close to the excavation area prior to proceeding with planned proving works (i.e. hand or NDD (e.g. Hydro-Vacuum Excavation). Any non-recorded assets should be identified prior to breaking ground (e.g. excavation or cutting).
- A check for gas leaks has been conducted prior to the commencement of work.
- If the mechanical excavation operator cannot see the spotter (where applicable, APA Site Watch Officer), he or she must stop moving immediately and not resume movement until contact has been established. Spotters must be aware of their surroundings and should never walk into the path of a vehicle, moving equipment or a swinging load. They need to scan the ground to become aware of any trip or fall hazards.
- If excavations are greater than 1.5 m or ground conditions are considered unstable benching/ battering/ shoring must be utilised. Additionally, appropriate ladders/ ramps or steps must be utilised to ensure safe access and egress.
- **Under no circumstances is mechanical equipment to be used within 300 mm of any gas asset.**

5.5.2 Physically Proving Gas Assets

Prior to mechanical excavation of the gas assets, the asset shall be physically proven by NDD or through the use of hand excavation. The method used will vary based on the criticality of the asset. The requirements in **Section 5.5.1** shall be implemented prior to physically proving the gas asset.

Technique 1 – Vacuum Excavation (Critical and Non-Critical Gas Assets)

A vacuum truck can be used to prove and expose the gas asset. Please ensure the requirements detailed in **Section 5.5.3** are adhered to.

Technique 2 – Hand Excavation (Critical and Non-Critical Gas Assets)

If the anticipated depth of cover of the gas asset is less than 1m (measured from the top of pipe) then hand excavation shall be used to expose the gas asset. The use of round edge shovels should be used to avoid damage to the pipe or coating. In the event that the anticipated depth of cover of the gas asset is greater than 1m then mechanical excavation can be undertaken in accordance with the requirements of **Section 5.5.4** but must stop when within 1m of the gas asset (i.e. 1.3m anticipated depth means that 300 mm of cover can be removed by mechanical excavation and the



remainder by hand excavation as described above. The anticipated depth shall be based on the shallowest result from BYDA or pipe locator.

Technique 3 – Hand + Excavation (Non-Critical Gas Assets ONLY)

If the gas asset is deemed non-critical then a combination of hand digging and excavation can be used. This technique requires the third party to hand excavate 300 mm then mechanically excavate the first 150 mm. In this technique the hand excavation shall always lead the mechanical excavation by 150 mm. Once within 300 mm of the gas asset then only hand excavation is allowed.

5.5.3 Hydro-Vacuum Excavation

Where hydro-vacuum excavation is used in the vicinity or to expose existing gas assets, the following conditions must be applied:

- Ensure the general requirements in **Section 5.5.1** are adhered to prior to the works commencing.
- Root cutting heads shall not be used at any time.
- When locating pipelines and mains, a maximum water pressure of 2500 PSI (17200 kPa) may be used to a depth no greater than 450 mm. Below this depth, the maximum water pressure shall be set in accordance with **Table 10** for the asset type in the vicinity.
- When locating customer offtakes (services), a maximum water pressure of 2500 PSI (17200 kPa) may be used to a depth no greater than 300 mm. Below this depth, the maximum water pressure shall be set in accordance with **Table 10** for the asset type in the vicinity.
- Where air is used in place of water the air pressure shall not exceed 175 PSI (1200 kPa).
- A minimum distance of 200 mm shall be maintained between the nozzle tip and subsoil and vertical movements avoided (i.e. nozzle shall not touch or be inserted into soil).
- The wand shall never remain motionless during excavation. Aiming directly at the gas asset shall be avoided at all times.
- NDD vacuum equipment must not come into contact (impact) with the pipe or coating.
- Once a gas asset has been exposed via hydro-vacuum methods, a visual check must be undertaken to ensure no damage has occurred to the pipe or its coating. Damage caused to the pipe coating by the third party will be chargeable.
- A dead man trigger or similar, shall be installed and used on the wand.
- If conduits are to be installed for identification of the gas assets location the conduit shall be offset to one side and recorded or a flexible conduit installed over the gas asset. The placement of PVC pipes directly on the gas asset may cause damage to the pipe coating and require repair at the contractor's expense.
- Vacuum excavated holes shall be cleaned of any rocks and debris and backfilled with a minimum 300 mm of sand.

Personnel operating NDD equipment shall monitor ground conditions to determine and adjust for the lowest water pressure setting and vacuum used to adequately expose the gas asset. The objective shall be to use the lowest possible pressure and vacuum required to adequately excavate in order to minimise risk of coating and/or pipe damage. **Table 10** provides the maximum water pressure to be used for various pipe and coating types.



Table 10 Maximum Water Pressure for Hydro-Vacuum Excavation

Pipe / Coating Type		Max. Water Pressure (PSI)	Pipe / Coating Type	Max. Water Pressure (PSI)
Steel	Coal Tar Enamel Coated	1,000	Steel – Mummified fittings (e.g. valves, flanges)	Not Permitted
	Polyethylene Tape Coated	1,000	Cast Iron	1,000
	Polyethylene Coated	2,000	Polyethylene	2,000
	Trilaminate Coated	2,000	Nylon or PVC	1,500
	FBE or HBE Coated	2,000	Unknown Material or Steel Pipe Coating	1,000
	Uncoated	2,500		

5.5.4 Mechanical Excavation

Prior to commencing any excavation works the general requirements in **Section 5.5.1** must be adhered to.

Where works are to be carried out within 3 m of the gas alignment and to 1 m of the known gas main depth, the contractor is required to pothole and expose the gas asset as outlined in **Section 5.5.5**.

Prior to the mechanical excavation commencing ensure the excavator is in working order and all pre-start equipment checks are completed.

Excavators with general purpose buckets (e.g. mud bucket, general purpose teeth) up to 30 tonnes are permitted to conduct mechanical excavations in the vicinity of existing APA gas assets in accordance with APA requirements. Any variation of excavator size or bucket type will require assessment and approval by APA Networks. Buckets with any type of tiger or penetration teeth are not permitted unless explicitly approved by APA Networks.

Critical Gas Assets

No mechanical equipment shall be used within 1 m of the potholed depth of the critical gas asset, except under explicit on site direction from an APA representative (i.e. APA Site Watch).

Under no circumstances is mechanical equipment to be used within 300 mm of any gas asset.

Once the gas asset has been positively proven, as outlined in **Section 5.5.2**, mechanical excavations can commence at a minimum of 300 mm offset from the outer edge of the pipe. The third party shall not mechanical excavate directly over a critical gas asset, with hand excavation only directly over the alignment or to expose the asset.

Figure 3 Gas Asset Side Excavation Method

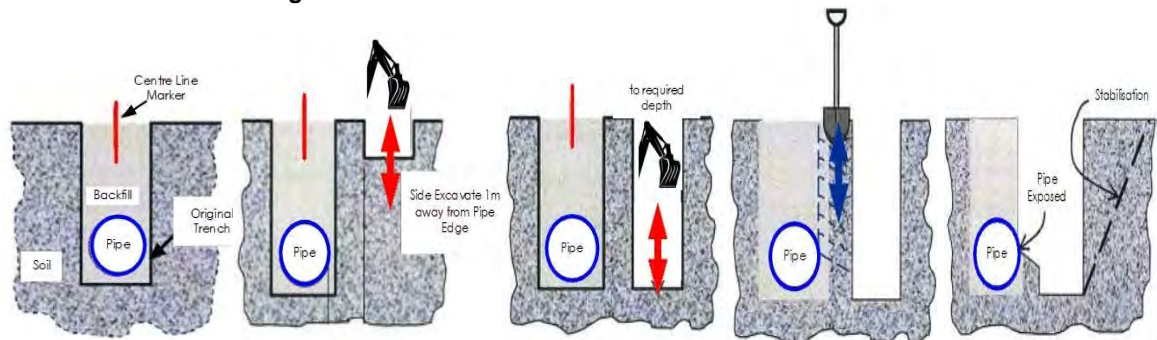



Non-Critical Gas Assets

Mechanical excavation is permitted directly over the top of non-critical gas assets however **under no circumstances is mechanical excavation equipment to be used within 300 mm of any gas asset.** If the third party is in doubt with regards to the criticality of the gas asset, then the excavation method outlined for critical gas assets shall be used.

Prior to the mechanical excavation commencing, the asset shall be physically proved as outlined in **Section 5.5.2**. Once the depth has been physically proven the third party can proceed with excavating around the gas asset until within 300 mm. From this point hand excavation or NDD is required.

5.5.6 Protection During Exposure

Additional protection measures are required where an exposed gas asset may be subject to impact from construction activities, sagging of exposed pipe and trench instability. Any works requiring exposure and protection of the gas asset should have an accompanying methodology and approval by APA Networks.

Physical protection (e.g. structural steel protection, sandbags, wrapped with split PVC pipe) should be installed around the exposed gas asset when exposed, particularly when new infrastructure is planned to be installed crossing below the gas asset. If the gas asset is to be exposed for longer than one day or otherwise left unattended, suitable barricades, security fencing and/ or steel plates will be required to provide protection from vehicles, dropped objects (such as construction materials) or vandalism.

Unsupported exposed pipe lengths require protection from sagging by using suitable supports such as sandbags or slings. Where slings or other support types come into contact with the gas asset, protection methods must be employed (e.g. wrapped with split PVC pipe) to prevent damage to the existing pipe or coating. Exposed unsupported joints must also be identified and supported during works. The maximum allowable length of exposed pipe without support is provided in **Table 11**.

Table 11 Maximum Unsupported Lengths of Exposed Pipe

Gas Asset Diameter (mm)	Steel Maximum Unsupported Length (mm)	Polyethylene Maximum Unsupported Length (mm)	Other Maximum Unsupported Length (mm)	Material
≤20	2,000	1,500	1,500 (Note 1)	
>20 & ≤63	2,800	2,000		
>63 & ≤100	3,600	3,000		
>100 & ≤150	4,200			
>150 & ≤250	5,000			
>250	5,700			

Note 1: Particular care should be taken for other materials include cast iron, PVC or nylon due to the unpredictable nature of the joints.

Additional protection and support during trench or bell-hole excavation works to minimise ground instability may also be necessary to protect the integrity of existing gas assets during exposure works. Trenches are to be inspected prior to commencing works each day and monitored by the onsite party responsible for the excavation. APA shall be notified of any condition likely to affect the stability of trench.

Any deep excavations, within 3 m of a gas asset, shall be designed and constructed such that the effects of subsidence, collapse or extreme weather will not affect the gas asset. Any such excavations prepared by a third party must be accompanied by certification from a registered practising engineer (RPEQ required for works in Queensland, and so on as required for other States and Territories) confirming that the design is adequate to protect the gas asset.



5.5.7 Backfill and Reinstatement

Prior to backfilling, a minimum of 150 mm of bedding sand must be placed around all gas assets. Bedding sand shall be in accordance with APA specification **400-SP-L-0002**, which can be provided to third parties upon request. The bedding must be compacted in accordance with **Section 5.10**, including suitable compaction and backfill of the underside of the gas asset to prevent any further vertical movement during subsequent layers above the asset. APA may require geo-fabric installation between different trench reinstatement products to prevent sand migration in which nonwoven fabric is required and needs to extend 1000 mm past either side of the utility crossing.

The bedding material shall be clean, free from all sharp objects, sandbags, clay material, vegetable matter, building debris and disused road paving material to the specification provided by APA. Recycled bedding material and stabilised sand must not be used unless explicitly approved by APA.

The remainder of the excavation shall be backfilled and compacted in accordance with **Section 5.10**, at maximum increments of 300 mm to a density which is similar to the surrounding sub-grade material. Only clean fill material shall be used, preferably the same as the natural soil in the area, and free from ash, weeds and pest plants, salt or any chemicals which could harm the gas assets. Where required, concrete slabbing shall be installed in accordance with **Section 5.4**.

In all circumstances gas warning tape / marker board shall be installed in accordance with the following requirements:

- Gas warning tape installed at 300 mm below finished surface level.
- Gas marker board installed 300 mm above the top of the pipe.

Note, where gas warning tape cannot be installed 300 mm below the finished surface level due to road pavement box out, marker board is to be installed 50 mm below the box out work zone.

In situations where a physical protection slab or bridging slab has been utilised an additional layer of gas marker board must be installed 50 mm above the slabbing.

The excavated area is to be reinstated to the original condition or as approved by APA and the relevant local council, road authority or landowner as applicable. Any marker signs removed during excavation works must also be reinstated in original positions. Additional marker signs may be required at new infrastructure crossings as directed by APA.

5.6 Trenchless Excavation

Trenchless excavation covers horizontal directional drilling (**HDD**), boring, pipe bursting and tunnelling. These activities are considered high risk that require additional controls to prevent damage to existing gas assets. This includes proving the existing gas asset location and depth for all horizontal bores, as well as providing a witness trench to verify that the bore will pass the asset with sufficient separation.

A witness trench must be used in addition to live electronic tracking of the bore head. The witness trench must be prepared to the specification provided in **Table 12**. The progressive measurement of the length of the bore must also be made and plotted along its proposed direction to ensure the bore head has not missed the witness trench. The bore head must be exposed in the witness trench, when the crossing is above the existing gas asset.

For all assets installed via trenchless excavation a vertical separation aligning with the maximum borehole diameter (e.g. reamed diameter) shall be demonstrated. For transmission pressure and distribution pressure assets this vertical separation distance is 1000 mm and 600 mm, respectively.

If the works run parallel to a transmission pressure or critical gas assets a minimum separation distance of 3 m must be maintained. For non-critical gas assets, the minimum separation distance of 1 m must be maintained. For works running parallel to gas assets, proving of the actual location of the gas asset must occur every 4 m.

Note: It is expected that HDD operators working near gas assets hold the national competency RIICCM202 – Identify, location and protect underground service.



Table 12 Minimum Witness Trench Dimensions

Crossing Type	Witness Trench Depth	Witness Trench Dimensions
Crossing Above Existing Gas Asset	To bottom (invert) of gas asset	Witness trench shall be 1000 mm to 2000 mm in front of the gas asset on the approach side. Witness trench shall be min. 1500 mm long and 300 mm wide centred on bore centre line.
Crossing Below Existing Gas Asset	To bottom (invert) of gas asset plus 500 mm	

Dispensation may be considered where detailed long sections are provided for assessment by APA and where depths of existing gas assets or separation to the bore are greater than 2500 mm.

Pipe bursting is not permitted within 1000 mm of an existing gas asset.

5.7 Piles, Piers or Poles

No piling such as pile-driving, sheet-piling or hammer-piling is permitted within 15 m of an existing gas asset unless explicit consent has been provided by APA. In all instances, vertical bored (augured) piles, piers or poles are preferred.

Where installation of piles, piers or poles are proposed between 500 mm and 1000 mm clearance from a gas asset (distribution and transmission pressures, respectively), the area directly below the proposed pile, pier or post location must be excavated to a level equivalent to the bottom (invert) of the existing gas asset, and works started from that depth.

Note: Proving of the gas asset must be completed in accordance with the requirements set out in **Section 5.5.2** prior to the commencement of any works.

Temporary steel plates may also be installed between the gas asset and the proposed pile, pier or post used for vertical bore methods within this clearance to provide extra protection.

Note: Direct vibration monitoring on the gas main may be required depending upon the installation method utilised. Refer to **Section 5.9** for APA Networks vibration limits.

5.8 Hot Works for Construction Activities

Typical hot works include grinding, welding, thermal or oxygen cutting or heating, and other related heat producing or spark-producing operations. Heat sources or hot works must not impact gas assets, taking into consideration that the ground or adjacent structures may also be capable of transmitting heat.

In order to safely undertake hot works, response procedures in the event of fire or flammable gas detection must be prepared and monitoring for flammable gases must be undertaken during works.

APA must approve any hot works where there is less than 300 mm ground cover to buried gas assets, or within 5,000 mm of any exposed gas assets (including any pits or valve covers). A heat shield or barrier may be required to provide protection if it cannot be demonstrated that works can be undertaken without impacting the gas asset.

5.9 Vibration Limits

Significant vibration may arise from activities such as blasting, piling, tunnelling and HDD/boring.

To avoid damage to existing APA Networks operated pipes and coatings, the following vibration limits must not be exceeded at any point on the pipe:

- a) For cast iron mains: 5 mm/s maximum Peak Particle Velocity (**PPV**) measured on the pipe.
- b) For steel pipe with a coal tar enamel (**CTE**) coating or with poor coating health: 10 mm/s maximum PPV measured on the pipe.
- c) For non-coal tar enamel pipe coatings and other pipe materials (i.e. steel, PE, PVC or Nylon): 20 mm/s maximum PPV measured on the pipe.



d) For blasting, the above vibration limits can be increased if supported by calculations in accordance with Design Guidelines for Buried Steel Pipeline – American Lifelines Alliance American Society of Civil Engineers (**ASCE**) and approved in writing by an APA Networks Integrity Engineer.

Note: Cast iron mains are particularly susceptible to damage by vibration. The PPV limit may not prevent leaks from cast iron and may require additional gas leakage survey activities during works in accordance with **Section 5.3**.

For vibration monitoring adopt an alarm at 80% of the acceptable PPV value and when the alarm is activated, the work must stop and be re-assessed. Short incursions up to 100% are acceptable, for sustained periods of vibration longer than 5 minutes, works must be stopped.

The zone of influence for vibration assessment undertaken by the third party is shown below;

- For compaction, refer to **Table 13**.
- For trenchless excavation (HDD/ boring), refer to **Section 5.6**.
- For piling refer to **Section 5.7**.
- For blasting refer to **Section 5.11**.

5.10 Compaction Limits

Compaction activities such as establishing a base course for a road pavement may result in damage to the pipes and coatings of existing gas assets. Compaction limits in the vicinity of existing gas assets are summarised in **Table 13**.

Table 13 Maximum Compaction Limits

Horizontal Separation (m)	Minimum Cover to Top of Gas Asset (mm)	Compaction Limits
≤3 (Note 1)	300	Small handheld compactor only
	500	Large handheld compactor Maximum 4 tonne tandem drum static roller
	750	Maximum 8 tonne tandem drum static roller
	1200	Maximum 10 tonne tandem drum static roller subject to APA approval
>3 & ≤10	All	Maximum 8 tonne tandem drum vibrating roller
>10 & ≤15	All	Maximum 10 tonne tandem drum vibrating roller
>15	All	Any compaction method

Note 1: Compaction within 3 m of gas assets is limited to static rollers. If vibration compaction is necessary a robust vibration assessment and construction methodology signed off by an RPEQ for works in Queensland, and so on as required for other States and Territories, will need to be produced by the third party for review and approval by an APA Networks Integrity Engineer.

5.11 Blasting / Seismic Survey / Explosives

Blasting, seismic survey or the use of explosives is not permitted within 100 m of a gas asset unless explicit approval is provided by APA Networks. The size and quantity of the explosives to be used will determine how close to the pipeline blasting will be permitted. In all cases, blasting methods must be arranged to limit ground vibrations so that the peak particle velocity does not exceed acceptable limits. At no stages will blasting be permitted within 3 m of the pipeline.



5.12 Suspended Materials above Gas Assets and No Go Zones for Cranes

Where gas assets are exposed, no cranes, excavators or backhoes are permitted to carry or suspend materials directly over or across a gas asset without an APA Networks approved lifting plan and SWMS.

Outriggers must be set up outside a 3 m radius from gas assets unless otherwise approved by APA Networks in writing.

5.13 Temporary Materials

In all instances it is preferred that temporary materials (e.g. soil, shipping containers) are not stored on top of transmission pressure and critical gas assets. Temporary material must not restrict access and should be placed at least 1,500 mm from the alignment of these assets unless otherwise approved by APA Networks.

6 PART 4 - ALTERATION OF EXISTING GAS ASSETS

Where the proposed third party works do not comply with the requirements of this document, and adequate additional controls or a specialised engineering solutions cannot be developed, alteration of the existing gas assets will be required.

Gas asset alterations will only be undertaken under a Recoverable Works Agreement (**RWA**) appropriate to the scope and extent of the works required.

An Early Works Agreement (**EWA**) may also be required where works are proposed which require proving, engineering design activities or purchase of long lead items. This will allow for completion of these items prior to execution of a RWA and avoid delaying works.

If either or both these agreements are required, then APA Networks will enter negotiations with the relevant third party and any costs will be payable by that third party.

7 GLOSSARY OF TERMS AND ABBREVIATIONS

Table 14 Glossary of Terms and Abbreviations

Term/ Abbreviation	Meaning
AGN	Australian Gas Networks
APA	Each entity that forms part of the APA Group
APA Engineering Assessment	Covers technical assessments which may involve field integrity assessments that may or may not include the use of specialist Consultants managed by APA.
APA Networks Operated Assets	APA Networks acts as the asset operator on behalf of entities Australian Gas Networks (AGN), Allgas, APA, Origin and Queensland Nitrates (QNP) and operates in New South Wales, Northern Territory, Queensland, South Australia and Victoria.
APA Permit Issuing Officer	The APA Permit Issuing Officer is responsible for opening the Permit To Work, validating APA Networks assets have been located and being the Site Watch for works within the gas Easement or Protected Zone.
AS	Australian Standard
ASCE	American Society of Civil Engineers
ATWP	Authority to Work Permit
CTE	Coal Tar Enamel
Damage	Physical damage to and interference with APA's assets. Damage includes reducing design life, coating damage, dents, scratches, rupture, cutting of cathodic protection cables. Damage can also include potential impacts that APA pipelines can have on third party assets.
BYDA	Before You Dig Australia (previously known as Dial Before You Dig (DBYD))
DCVG	Direct Current Voltage Gradient
Depth of Cover	Vertical distance from the existing natural ground surface to the top of the buried gas asset
EPR	Earth Potential Rise
ESV	Energy Safe Victoria
EWA	Early Works Agreement

Excavation	Excavation refers to manual digging or mechanised digging operation with plant or equipment which involves trenching and trenchless excavation. Trenchless excavation covers boring, Horizontal Directional Drilling (HDD), pipe bursting and tunnelling.
FBE	Fusion Bonded Epoxy
GIS	Geographic Information System
HBE	High Build Epoxy
HDD	Horizontal Directional Drilling
Hot Works	Hot works are defined as grinding, welding, thermal or oxygen cutting or heating, and other related heat-producing or spark-producing operations. Heat sources or hot works must not impact pipelines, taking into consideration that the ground or adjacent structures may also be capable of transmitting heat.
LFI	Low Frequency Induction
LPG	Liquefied Petroleum Gas
MAOP	Maximum Allowable Operating Pressure
Measurement Length	<p>The maximum length of pipeline route which presents an extended source of hazard on the basis that an event of failure could affect any part of the development or specific location relevant to the development.</p> <p>The maximum length corresponds to the heat radiation hazard associated with a 4.7 kW/m² heat radiation contour for an ignited full bore rupture calculated in accordance with AS/NZS 2885.6. If the pipeline is designed as a no rupture pipe, then the measurement length corresponds to a credible leak size.</p>
NDD	Non-Destructive Digging (NDD) refers to either hand digging or Non-Destructive Pot Holing using a vacuum pipe connected to a vacuum truck with either a water lance or air lance. Hydro-Vacuum Excavation consists of a water lance and vacuum truck and is used to physically prove existing assets.
OHEW	Overhead Earth Wire
PE	Polyethylene
Pipe Bursting	Pipe bursting refers to a pipe being inserted to a larger pipe that results in the larger pipe being damaged. For an example of pipe bursting, refer to the following You-Tube video: https://www.youtube.com/watch?v=HX5beh0ubGY
Pipeline Easement	The pipeline area shown on a survey plan and referenced on the property title.
Predominate Building Line	The expected predominate building line relates to the façade of the building, not necessarily the property boundary.
Protected Zone	A Protected Zone is an area extending both horizontally and longitudinally along a gas asset. It is the area where loads and/or any hot works may potentially cause damage to the gas asset.



	The Protected Zone refers to works near APA Networks gas assets or works within the vicinity of the gas assets that may cause an unacceptable risk to the asset in accordance with Table 2 Minimum Clearances or Table 3 Minimum Clearances for Construction Works and Land Use Activities
PTW	Permit to Work
PPV	Peak Particle Velocity
PVC	Polyvinyl Chloride
QNP	Queensland Nitrates Plant
RPEQ	Registered Profession Engineer Queensland
RWA	Recoverable Works Agreement
Sensitive Use Locations	<p>This is designated as Class “S” as per AS/NZS 2885.6 Pipelines - Gas and liquid petroleum - Pipeline safety management and refers to the sub location class.</p> <p>Sensitive Use Location Class (S) identifies land where the consequences of a FAILURE EVENT may be increased because it is developed for use by sectors of the community who may be unable to protect themselves from the consequences of a pipeline FAILURE EVENT.</p> <p>Sensitive uses are defined as follows:</p> <ul style="list-style-type: none"> • Schools which includes colleges • Hospitals • Aged care facilities such as nursing homes, elderly people’s homes • Prisons and jails • Convalescent homes • Sheltered housing • Buildings with five or more stories • Large community and leisure facilities, large open air gatherings • Day care facilities • Other potentially difficult to evacuate facilities • Other structures as defined by relevant local councils. <p>The Sensitive Use Location Class “S” must be assigned to any section of a gas transmission pipeline where there is a sensitive development within the applicable Measurement Length.</p>



<p>Site Watch</p>	<p>An APA Site Watch representative can be the Permit Issuing Officer for excavation work within a gas Easement or Protected Zone and is referred to as the primary spotter for excavation works.</p> <p>The secondary spotter is provided by the Contractor.</p> <p>The primary spotter has the ultimate decision regarding works within the gas Easement or Protected Zone which includes the method of excavation, starting and stopping excavation work.</p> <p>The APA Site Watch representative is the nominated competent person responsible for the following;</p> <ul style="list-style-type: none"> • Making themselves highly visible and everyone on the job site should be aware of the Site Watch’s role; • Communication to personnel operating mobile plant and equipment ensuring minimum clearance to above and below ground assets is maintained and the construction methodology is adhered to and complies with APA Networks requirements. <p>Ensuring personnel do not encroach within the swing radius of the operating machinery.</p>
<p>SMS</p>	<p>Safety Management Study</p>
<p>SMWS</p>	<p>Safe Work Method Statement used by APA or Contractors to execute field work. The risks and associated control measures risk assessments should be transferred to SWMS.</p>
<p>SRZ</p>	<p>Structural Root Zone</p>
<p>Structures</p>	<p>Structures refer to third party structures which includes, but is not limited to; temporary or permanent buildings, walls, canopies, footings, pile caps or retaining walls</p>
<p>Third Party</p>	<p>The person or entity and their agents or Contractors that propose to undertake work near APA assets.</p>
<p>Third Party Assets</p>	<p>Third Party Assets include roads, utilities and structures.</p>
<p>Third Party Excavation</p>	<p>Third Party Excavation which is not associated with APA (e.g. road works, utility installation, private development, fencing).</p>
<p>Third Party Works Classification</p>	<p>The Third Party Work Classification as shown in Section 3.3 covers the following three work classifications:</p> <ol style="list-style-type: none"> 1. No Impact to gas assets 2. No Objection Under Conditions 3. Enquiry Escalated for Alteration
<p>Transmission Pipeline</p>	<p>Gas transmission pipeline which includes all associated equipment such as cathodic protection, earthing grid, instrumentation and electrical cables.</p>
<p>Utilities</p>	<p>Includes water, wastewater, drainage, telecommunications cables, power poles and cables owned by individuals or organisations other than APA Networks.</p>
<p>Voltage</p>	<p>Difference of potential normally between conductors or between conductors and earth as follows:</p> <ol style="list-style-type: none"> a) Extra-low voltage – Not exceeding 50V a.c. or 120 V ripple-free d.c. b) Low voltage – Exceeding extra-low voltage, but not exceeding 1000 V a.c. or 1500 V d.c.

Guidelines for Works Near Existing Gas Assets
400-STD-AM-0001 Revision 2



	c) High voltage – Exceeding low voltage.
Works	The development of any type of buildings, structures and other obstructions (including residential buildings, pools, sheds, carports, major developments, transport infrastructure, services, stockpiles, trees), and any work that causes changes to the ground (including movement of heavy vehicles, blasting, tunnelling, pile driving, ground compaction, earthworks, open and trenchless excavations)

8 DOCUMENT REFERENCES

Table 15 Document References

External Standards	
API RP 1102	Steel Pipeline Crossing Railroads and Highways
AS 2832.1	Cathodic protection of metals: Pipes and cables
AS 2885.0	Pipelines – Gas and liquid petroleum: General requirements
AS/NZS 2885.1	Pipelines – Gas and liquid petroleum: Design and Construction
AS/NZS 2885.2	Pipelines – Gas and liquid petroleum: Welding
AS 2885.3	Pipelines – Gas and liquid petroleum: Operations and Maintenance
AS 2885.5	Pipelines – Gas and liquid petroleum: Field Pressure Testing
AS/NZS 2885.6	Pipelines – Gas and liquid petroleum: Pipeline safety management
AS/NZS 4645.1	Gas Distribution Networks - Network Management
AS/NZS 4645.2	Gas Distribution Networks - Steel Pipe Systems
AS/NZS 4645.3	Gas Distribution Networks - Plastics Pipe Systems
AS 4799	Installation of Underground Utility Services and Pipelines Within Railway Boundaries
AS 4827.1	Coating defect surveys for buried pipelines Part 1: Direct current voltage gradient (DCVG)
AS/NZS 4853	Electrical Hazards on Metallic Pipelines
AS 4970	Protection of trees on development sites
Standard Policies, Procedures, Specifications, Guidelines, Forms and Templates	
400-SP-L-0002	Networks Bedding Material Specification
400-PR-L-0003	Encroachment and Land Use Change SMS Trigger Procedure



APPENDIX A GENERAL DBYD RESPONSE PROCESS

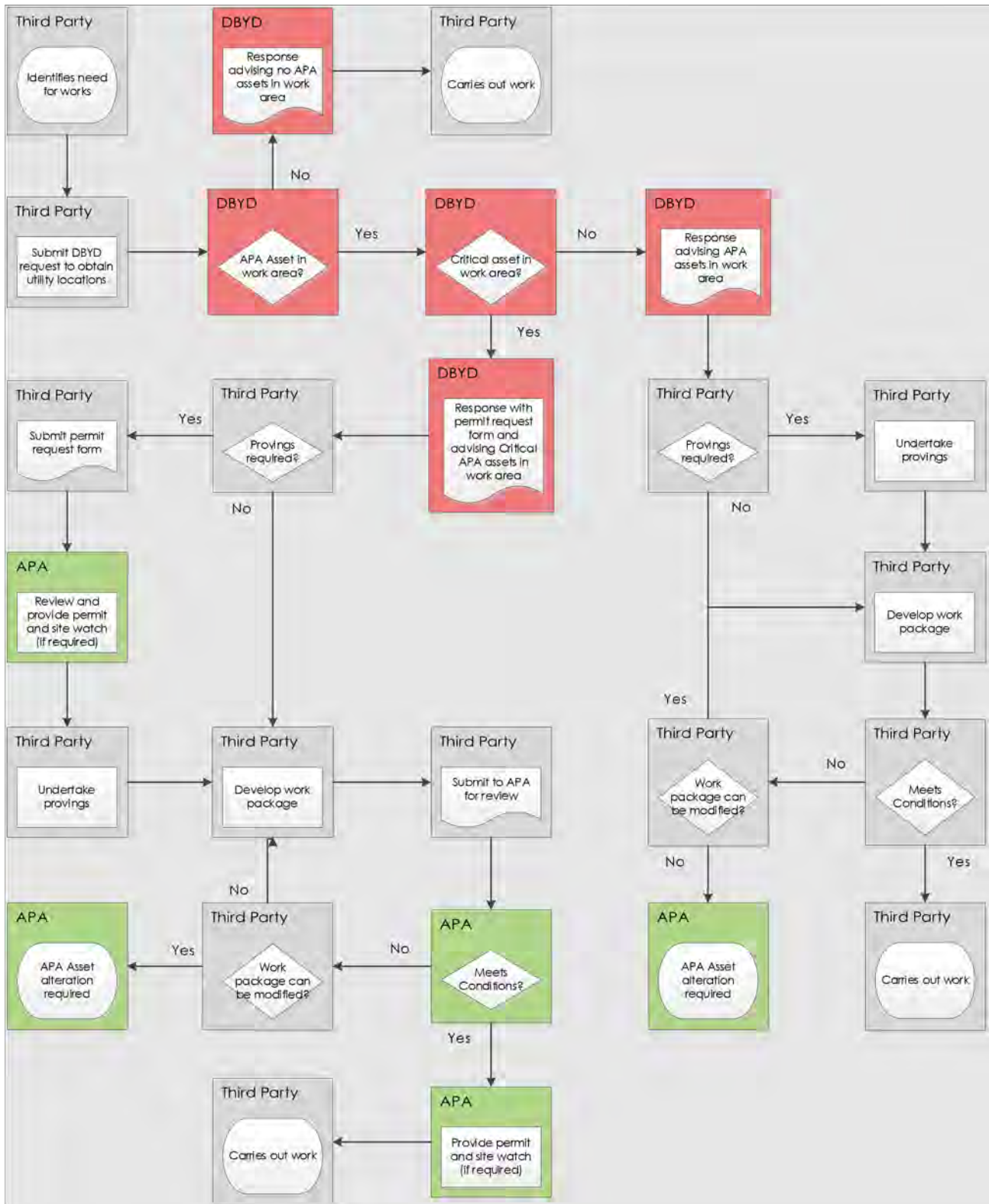

Job ID 51611592

Brisbane City Council

Referral
263708350

Member Phone
(07) 3403 8888

Responses from this member

Response received Wed 5 Nov 2025 11.55am

File name	Page
Response Body	57
ASSET 263708350.pdf	58

Attention: Info Request HPC

Thank you for your enquiry with Brisbane City Council's Before You Dig service.

Job Number: 51611592
Sequence Number: 263708350

The attached .PDF file contains the location of Council's relevant services for your requested location. If you are having trouble viewing these files, it is recommended you upgrade your version of Adobe Reader. You can download the latest version of Adobe Reader for free at <http://get.adobe.com/reader/>

If you require more information, Council offers a convenient online mapping subscription service containing additional services data. The online service offers a wide variety of spatial information suitable for searches over large areas, including information previously available only by visiting Council's Customer Service Centres.

For more information on Council's online mapping services, visit <http://www.brisbane.qld.gov.au/planning-building/planning-guidelines-and-tools/online-tools/ebimap/index.htm>

Kind regards,

Brisbane City Council
Before You Dig



Job # 51611592
Seq # 263708350
 Provider: Brisbane City Council
 Telephone: (07) 3403 8888



Legend

- BYDA Enquiry

Stormwater Network

- Stormwater Drain
- Stormwater Gully / Roofwater Connection
- Stormwater Maintenance Hole
- Stormwater Roofwater Pit
- Stormwater Gully Pit

Disclaimer:
 © Brisbane City Council [2020]
 In consideration of Council, and the copyright owners listed below, permitting the use of this data, you acknowledge and agree that Council, and the copyright owners, give no warranty in relation to the data (including accuracy, reliability, completeness, currency or suitability) and accept no liability (including without limitation, liability in negligence) for any loss, damage or costs (including consequential damage), relating to any use of this data.
 Data must not be used for direct marketing or be used in breach of the privacy laws.

Copyright of data is as follows:
 Cadastre and Street Names © 2020 State of Queensland (Department of Natural Resources, Mines and Energy)

Caution: This map may contain the locations of abandoned underground asbestos pipes. Council gives no warranty to the completeness or accuracy of these records. Appropriate care needs to be taken in all cases.

In an emergency contact Brisbane City Council on 07 3403 8888
05/11/25 (valid for 30 days)

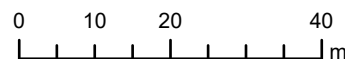

Scale 1:1,000



Plans generated by SmarterWX™ Automate

Job ID 51611592

NBN Co Qld

Referral
263708349

Member Phone
1800 687 626

Responses from this member

Response received Wed 5 Nov 2025 11.58am

File name	Page
Response Body	60
263708349_20251105_015739147884_1.pdf	61
4678_NBN_Dial_Before_You_Dig_Poster_20170517.pdf	64
Disclaimer_263708349_20251105_015739147884.pdf	66

Hi Info Request HPC,

Please find attached the response to your DBYD referral for the address mentioned in the subject line. The location shown in our DBYD response is assumed based off the information you have provided. If the location shown is different to the location of the excavation then this response will consequently be rendered invalid.

Take the time to read the response carefully and note that this information is only valid for 28 days after the date of issue.

If you have any further enquiries, please do not hesitate to contact us.

Regards,
Network Services and Operations
NBN Co Limited
P: 1800626329
E: dbyd@nbnco.com.au
www.nbnco.com.au

Confidentiality and Privilege Notice

This e-mail is intended only to be read or used by the addressee. It is confidential and may contain legally privileged information. If you are not the addressee indicated in this message (or responsible for delivery of the message to such person), you may not copy or deliver this message to anyone, and you should destroy this message and kindly notify the sender by reply e-mail. Confidentiality and legal privilege are not waived or lost by reason of mistaken delivery to you. Any views expressed in this message are those of the individual sender, except where the sender specifically states them to be the views of NBN Co Limited

Please Do Not Reply To This Mail

To: Info Request HPC
Phone: Not Supplied
Fax: Not Supplied
Email: inforequest.hpc@harcourts.com.au

Dial before you dig Job #:	51611592	
Sequence #	263708349	
Issue Date:	05/11/2025	
Location:	24 Alkoomie St , Wynnum , QLD , 4178	

Indicative Plans are tiled below to demonstrate how to layout and read nbn asset plans

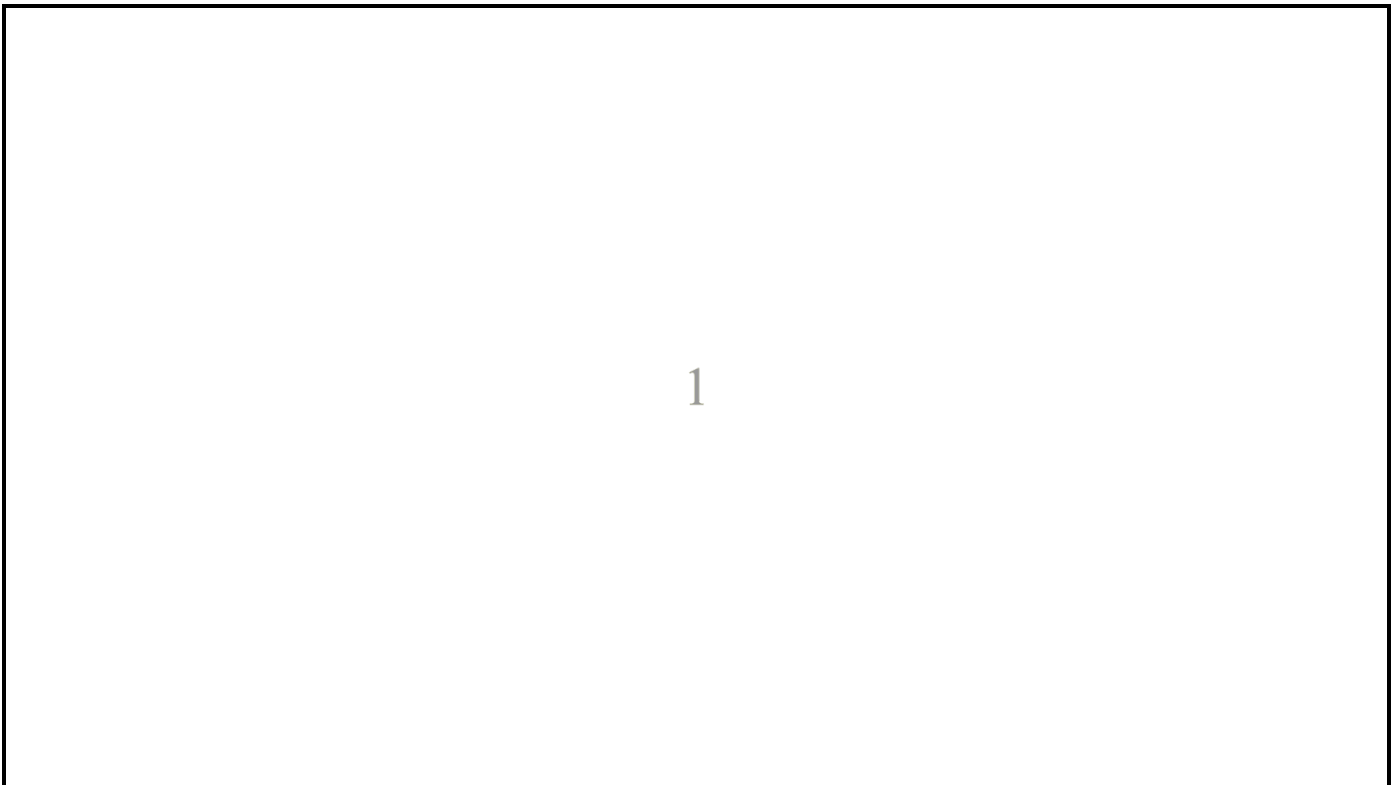



LEGEND

	Parcel and the location
	Pit with size "5"
	Power Pit with size "2E". Valid PIT Size: e.g. 2E, 5E, 6E, 8E, 9E, E, null.
	Manhole
	Pillar
<p style="text-align: center;">2 PO – T- 25.0m P40 – 20.0m</p>	Cable count of trench is 2. One "Other size" PVC conduit (PO) owned by Telstra (-T-), between pits of sizes, "5" and "9" are 25.0m apart. One 40mm PVC conduit (P40) owned by NBN, between pits of sizes, "5" and "9" are 20.0m apart.
<p style="text-align: center;">2 10.0m</p>	2 Direct buried cables between pits of sizes, "5" and "9" are 10.0m apart.
	Trench containing any INSERVICE/CONSTRUCTED (Copper/RF/Fibre) cables.
	Trench containing only DESIGNED/PLANNED (Copper/RF/Fibre/Power) cables.
	Trench containing any INSERVICE/CONSTRUCTED (Power) cables.
<p style="text-align: center;">BROADWAY ST</p>	Road and the street name "Broadway ST"
<p style="text-align: center;">Scale</p>	<p style="text-align: center;">0 20 40 60 Meters</p> <p style="text-align: center;">1:2000 1 cm equals 20 m</p>

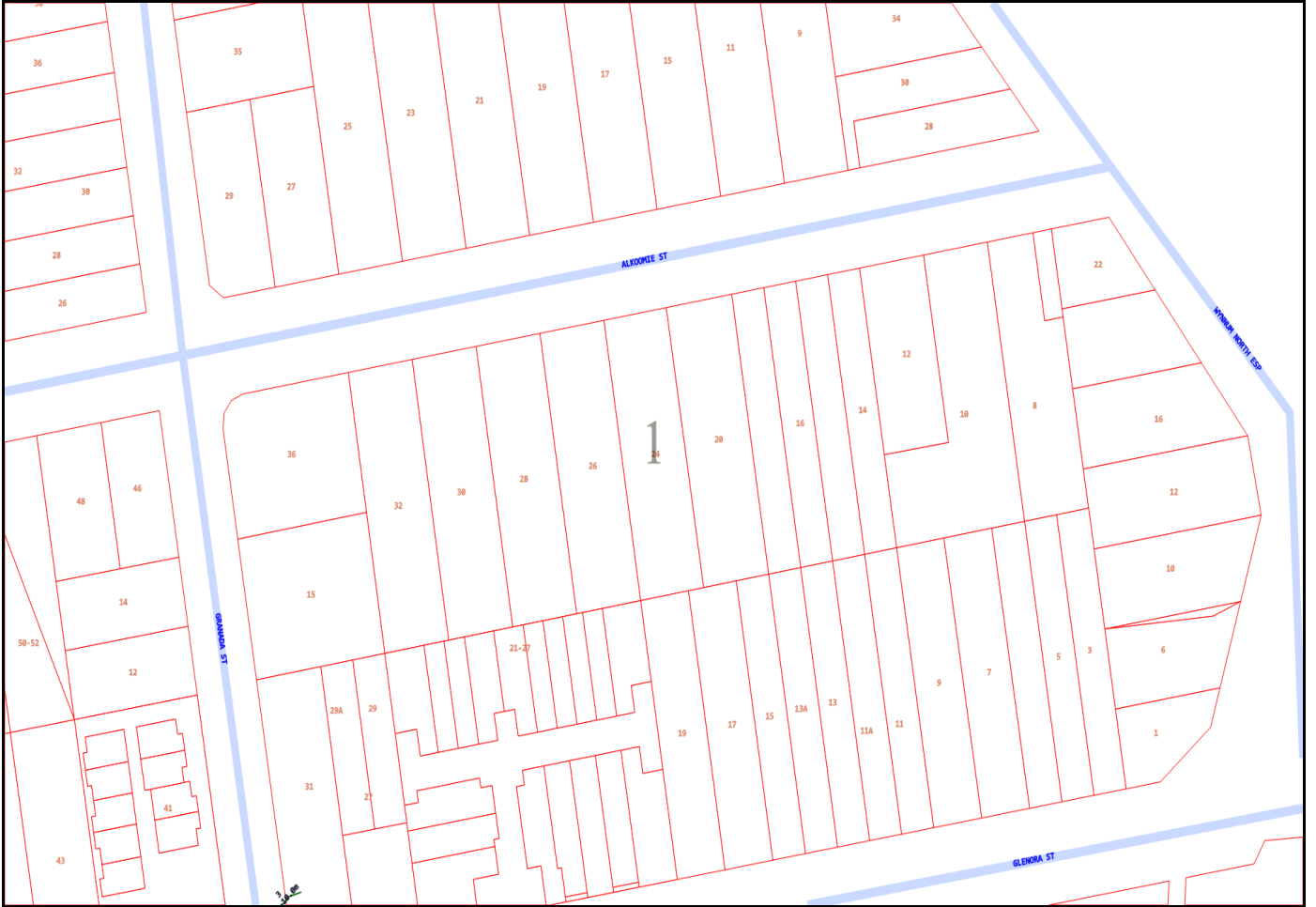

Emergency Contacts

You must immediately report any damage to the **nbn**™ network that you are/become aware of. Notification may be by telephone - 1800 626 329.



Working near nbn™ cables

nbn has partnered with Dial Before You Dig to give you a single point of contact to get information about **nbn** underground services owned by **nbn** and other utility/service providers in your area including communications, electricity, gas and other services. Contact with underground power cables and gas services can result in serious injury to the worker, and damage and costly repairs. You must familiarise yourself with all of the Referral Conditions (meaning the referral conditions referred to in the DBYD Notice provided by **nbn**).

Practice safe work habits

Once the DBYD plans are reviewed, the Five P's of Excavation should be adopted in conjunction with your safe work practices (which must be compliant with the relevant state Electrical Safety Act and Safe Work Australia "Excavation Work Code of Practice", as a minimum) to ensure the risk of any contact with underground **nbn** assets are minimised.



Plan: Plan your job by ensuring the plans received are current and apply to the work to be performed. Also check for any visual cues that may indicate the presence of services not covered in the DBYD plans.



Prepare: Prepare for your job by engaging a DBYD Certified Plant Locator to help interpret plans and identify on-site assets. Contact **nbn** should you require further assistance.



Pothole: Non-destructive potholing (i.e. hand digging or hydro excavation) should be used to positively locate **nbn** underground assets with minimal risk of contact and service damage.

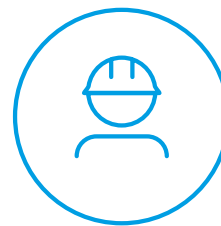

Protect: Protecting and supporting the exposed **nbn** underground asset is the responsibility of the worker. Exclusion zones for **nbn** assets are clearly stated in the plan and appropriate controls must be implemented to ensure that encroachment into the exclusion zone by machinery or activities with the potential to damage the asset is prevented.



Proceed: Proceed only when the appropriate planning, preparation, potholing and protective measures are in place.

Working near **nbn**TM cables

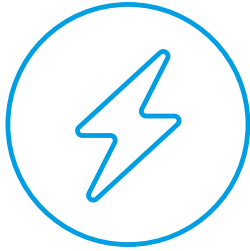

Identify all electrical hazards, assess the risks and establish control measures.

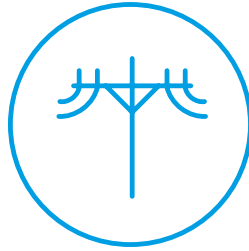

When using excavators and other machinery, also check the location of overhead power lines.

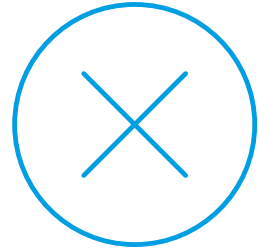

Workers and equipment must maintain safety exclusion zones around power lines.

Once all work is completed, the excavation should be re-instated with the same type of excavated material unless specified by **nbn**. Please note:

- Construction Partners of **nbn** may require additional controls to be in place when performing excavation activities.
- The information contained within this pamphlet must be used in conjunction with other material supplied as part of this request for information to adequately control the risk of potential asset damage.

Contact

All **nbn**TM network facility damages must be reported online [here](#).
For enquiries related to your DBYD request please call 1800 626 329.

Disclaimer

This brochure is a guide only. It does not address all the matters you need to consider when working near our cables. You must familiarise yourself with other material provided (including the Referral Conditions) and make your own inquiries as appropriate.

nbn will not be liable or responsible for any loss, damage or costs incurred as a result of reliance on this brochure.

This document is provided for information purposes only. This document is subject to the information classification set out on this page. If no information classification has been included, this document must be treated as UNCLASSIFIED, SENSITIVE and must not be disclosed other than with the consent of nbn co. The recipient (including third parties) must make and rely on their own inquiries as to the currency, accuracy and completeness of the information contained herein and must not use this document other than with the consent of nbn co. Copyright © 2021 nbn co limited. All rights reserved.



To: Info Request HPC
Phone: Not Supplied
Fax: Not Supplied
Email: inforequest.hpc@harcourts.com.au

Before You Dig Australia Job #:	51611592	
Sequence #	263708349	
Issue Date:	05/11/2025	
Location:	24 Alkoomie St , Wynnum , QLD , 4178	

Information

The area of interest requested by you contains one or more assets.

nbn™ Assets	Search Results
Communications	Asset identified
Electricity	No assets

In this notice **nbn™ Facilities** means *underground fibre optic, telecommunications and/or power facilities, including but not limited to cables, owned and controlled by nbn™*

Location of nbn™ Underground Assets

We thank you for your enquiry. In relation to your enquiry at the above address:

- **nbn's** records indicate that there **ARE nbn™** Facilities in the vicinity of the location identified above ("Location").
- **nbn** indicative plan/s are attached with this notice ("Indicative Plans").
- The Indicative Plan/s show general depth and alignment information only and are not an exact, scale or accurate depiction of the location, depth and alignment of **nbn™** Facilities shown on the Plan/s.
- In particular, the fact that the Indicative Plans show that a facility is installed in a straight line, or at uniform depth along its length cannot be relied upon as evidence that the facility is, in fact, installed in a straight line or at uniform depth.
- You should read the Indicative Plans in conjunction with this notice and in particular, the notes below.
- You should note that, at the present time, the Indicative Plans are likely to be more accurate in showing location of fibre optics and telecommunications cables than power cables. There may be a variation between the line depicted on the Indicative Plans and the location of any power cables. As such, consistent with the notes below, particular care must be taken by you to make your own enquiries and investigations to precisely locate any power cables and manage the risk arising from such cables accordingly.
- The information contained in the Indicative Plan/s is valid for 28 days from the date of issue set out above. You are expected to make your own inquiries and perform your own investigations (including engaging appropriately qualified plant locators, e.g BYDA Certified Locators, at your cost to locate **nbn™** Facilities during any activities you carry out on site).

We thank you for your enquiry and appreciate your continued use of the Before You Dig Australia Service. For any enquiries related to moving assets or Planning and Design activities, please visit the [nbn Commercial Works](#) website to complete the online application form. If you are planning to excavate and require further information, please email dbyd@nbnco.com.au or call 1800 626 329.

Notes:

1. You are now aware that there are **nbn™** Facilities in the vicinity of the above property that could be damaged as a result activities carried out (or proposed to be carried out) by you in the vicinity of the Location.
2. You should have regard to section 474.6 and 474.7 of the *Criminal Code Act 1995* (CoA) which deals with the consequences of interfering or tampering with a telecommunications facility. Only persons authorised by **nbn** can interact with **nbn's** network facilities.
3. Any information provided is valid only for **28 days** from the date of issue set out above.

Referral Conditions

The following are conditions on which **nbn** provides you with the Indicative Plans. By accepting the plans, you are agreeing to these conditions. These conditions are in addition, and not in replacement of, any duties and obligations you have under applicable law.

1. **nbn** does not accept any responsibility for any inaccuracies of its plans including the Indicative Plans. You are expected to make your own inquiries and perform your own investigations (including engaging appropriately qualified plant locators, e.g BYDA Certified Locators, at your cost to locate **nbn™** Facilities during any activities you carry out on site).
2. You acknowledge that **nbn** has specifically notified you above that the Indicative Plans are likely to be more accurate in showing location of fibre optics and telecommunications cables than power cables. There may be a variation between the line depicted on the Indicative Plans and the location of any power cables.
3. You should not assume that **nbn™** Facilities follow straight lines or are installed at uniformed depths

along their lengths, even if they are indicated on plans provided to you. Careful onsite investigations are essential to locate the exact position of cables.

4. In carrying out any works in the vicinity of **nbn**™ Facilities, you must maintain the following minimum clearances:
 - 300mm when laying assets inline, horizontally or vertically.
 - 500mm when operating vibrating equipment, for example: jackhammers or vibrating plates.
 - 1000mm when operating mechanical excavators.
 - Adherence to clearances as directed by other asset owner's instructions and take into account any uncertainty for power cables.
5. You are aware that there are inherent risks and dangers associated with carrying out work in the vicinity of underground facilities (such as **nbn**™ fibre optic, copper and coaxial cables, and power cable feed to **nbn**™ assets). Damage to underground electric cables may result in:
 - Injury from electric shock or severe burns, with the possibility of death.
 - Interruption of the electricity supply to wide areas of the city.
 - Damage to your excavating plant.
 - Responsibility for the cost of repairs.
6. You must take all reasonable precautions to avoid damaging **nbn**™ Facilities. These precautions may include but not limited to the following:
 - All excavation sites should be examined for underground cables by careful hand excavation. Cable cover slabs if present must not be disturbed. Hand excavation needs to be undertaken with extreme care to minimise the likelihood of damage to the cable, for example: the blades of hand equipment should be aligned parallel to the line of the cable rather than digging across the cable.
 - If any undisclosed underground cables are located, notify **nbn** immediately.
 - All personnel must be properly briefed, particularly those associated with the use of earth-moving equipment, trenching, boring and pneumatic equipment.
 - The safety of the public and other workers must be ensured.
 - All excavations must be undertaken in accordance with all relevant legislation and regulations.
7. You will be responsible for all damage to **nbn**™ Facilities that are connected whether directly, or indirectly with work you carry out (or work that is carried out for you or on your behalf) at the Location. This will include, without limitation, all losses expenses incurred by **nbn** as a result of any such damage.
8. You must immediately report any damage to the **nbn**™ network that you are/become aware of. Notification may be by telephone - 1800 626 329.
9. Except to the extent that liability may not be capable of lawful exclusion, **nbn** and its servants and agents and the related bodies corporate of **nbn** and their servants and agents shall be under no liability whatsoever to any person for any loss or damage (including indirect or consequential loss or damage) however caused (including, without limitation, breach of contract negligence and/or breach of statute) which may be suffered or incurred from or in connection with this information sheet or any plans (including Indicative Plans) attached hereto. Except as expressly provided to the contrary in this information sheet or the attached plans (including Indicative Plans), all terms, conditions, warranties, undertakings or representations (whether expressed or implied) are excluded to the fullest extent permitted by law.

All works undertaken shall be in accordance with all relevant legislations, acts and regulations applicable to the particular state or territory of the Location. The following table lists all relevant documents that shall be considered and adhered to.

State/Territory	Documents
National	Work Health and Safety Act 2011
	Work Health and Safety Regulations 2011
	Safe Work Australia - Working in the Vicinity of Overhead and Underground Electric Lines (Draft)

	Occupational Health and Safety Act 1991
NSW	Electricity Supply Act 1995
	Work Cover NSW - Work Near Underground Assets Guide
	Work Cover NSW - Excavation Work: Code of Practice
VIC	Electricity Safety Act 1998
	Electricity Safety (Network Asset) Regulations 1999
QLD	Electrical Safety Act 2002
	Code of Practice for Working Near Exposed Live Parts
SA	Electricity Act 1996
TAS	Tasmanian Electricity Supply Industry Act 1995
WA	Electricity Act 1945
	Electricity Regulations 1947
NT	Electricity Reform Act 2005
	Electricity Reform (Safety and Technical) Regulations 2005
ACT	Electricity Act 1971

Thank You,

nbn BYDA

Date: 05/11/2025

This document is provided for information purposes only. This document is subject to the information classification set out on this page. If no information classification has been included, this document must be treated as UNCLASSIFIED, SENSITIVE and must not be disclosed other than with the consent of nbn co. The recipient (including third parties) must make and rely on their own inquiries as to the currency, accuracy and completeness of the information contained herein and must not use this document other than with the consent of nbn co.

Copyright © 2021 nbn co Limited. All rights reserved.

Job ID 51611592

Queensland Urban Utilities

Referral

263708351

Member Phone

13 26 57

Responses from this member

Response received Wed 5 Nov 2025 11.58am

File name

Page

Response Body

71

263708351 - Urban Utilities Plan.pdf

73

Urban Utilities Important Information.pdf

74



GPO Box 2765
Brisbane QLD 4001

Date: 05 Nov 2025

Before You Dig Australia Response

Please DO NOT SEND A REPLY to this email as it has been automatically generated and replies are not monitored.

Dear Info Request HPC

We appreciate your diligence in contacting the Before You Dig Australia service (**BYDA**) prior to engaging in work or activities which may affect the water and sewerage infrastructure of Urban Utilities.

Job Number:	51611592
Sequence Number:	263708351
Enquiry Date:	5/11/2025 12:55:00 PM
Enquiry Location:	24 Alkoomie St Wynnum QLD 4178

WARNING: When working in the vicinity of Urban Utilities' assets you have a legal *Duty of Care* that must be observed.

Our records indicate the presence of infrastructure owned by Urban Utilities within your nominated search area, as shown on the attached plan.

Please note that you may be liable for any loss or damage to our infrastructure which is caused by any works or activities which you undertake over or near such infrastructure. Additionally, your works or activities may conflict with other works scheduled in your nominated search area. To avoid any unnecessary impacts, before any undertaking you must obtain the following approvals:

- And/or a Urban Utilities Network Access Permit for self assessable works or activities that are within two metres of our infrastructure (refer to [Urban Utilities Network Access Permit Webpage](#))
- Either a Build Over Asset (BOA) Approval for assessable building works undertaken within specified distances of our infrastructure (refer to [DHPW BOA Factsheet](#))

We have provided additional information about your responsibilities in relation to our infrastructure in the Important Information sheet attached to this letter. By accessing BYDA to obtain our records about our infrastructure, you warrant that you have read the sheet and agree to the terms and conditions set out therein.

For further enquiries or assistance with interpretation of plans and search content please contact our BYDA Support Team by email networkaccess@urbanutilities.com.au. Alternatively, you can write to us at Urban Utilities, PO Box 2765, Brisbane QLD 4001.

Thank you for taking the time to consult the BYDA service.

Yours sincerely

Before You Dig Australia Support Team
Urban Utilities
networkaccess@urbanutilities.com.au

To best manage the risk of damage and liability, we recommend that you engage the services of a [BYDA Certified Locator](#)

Important Notice

This enquiry response, including any associated documentation, has been assessed and compiled from the information detailed within the BYDA enquiry outlined above. **Please ensure that the BYDA enquiry details and this response accurately reflect your proposed works.**

This response is intended for use only by the addressee. If you have received the enquiry response in error, please let us know by telephone and delete all copies; you are advised that copying, distributing, disclosing or otherwise acting in reliance on the response is expressly prohibited.

Disclaimer: While reasonable measures have been taken to ensure the accuracy of the information contained in this plan response, neither Urban Utilities nor PelicanCorp shall have any liability whatsoever in relation to any loss, damage, cost or expense arising from the use of this plan response or the information contained in it or the completeness or accuracy of such information. Use of such information is subject to and constitutes acceptance of these terms.

If you are unable to launch any of the files for viewing and printing, you may need to download and install free viewing and printing software such as [Adobe Acrobat Reader \(for PDF files\)](#).

Urban Utilities - Water, Recycled Water and Sewer Infrastructure

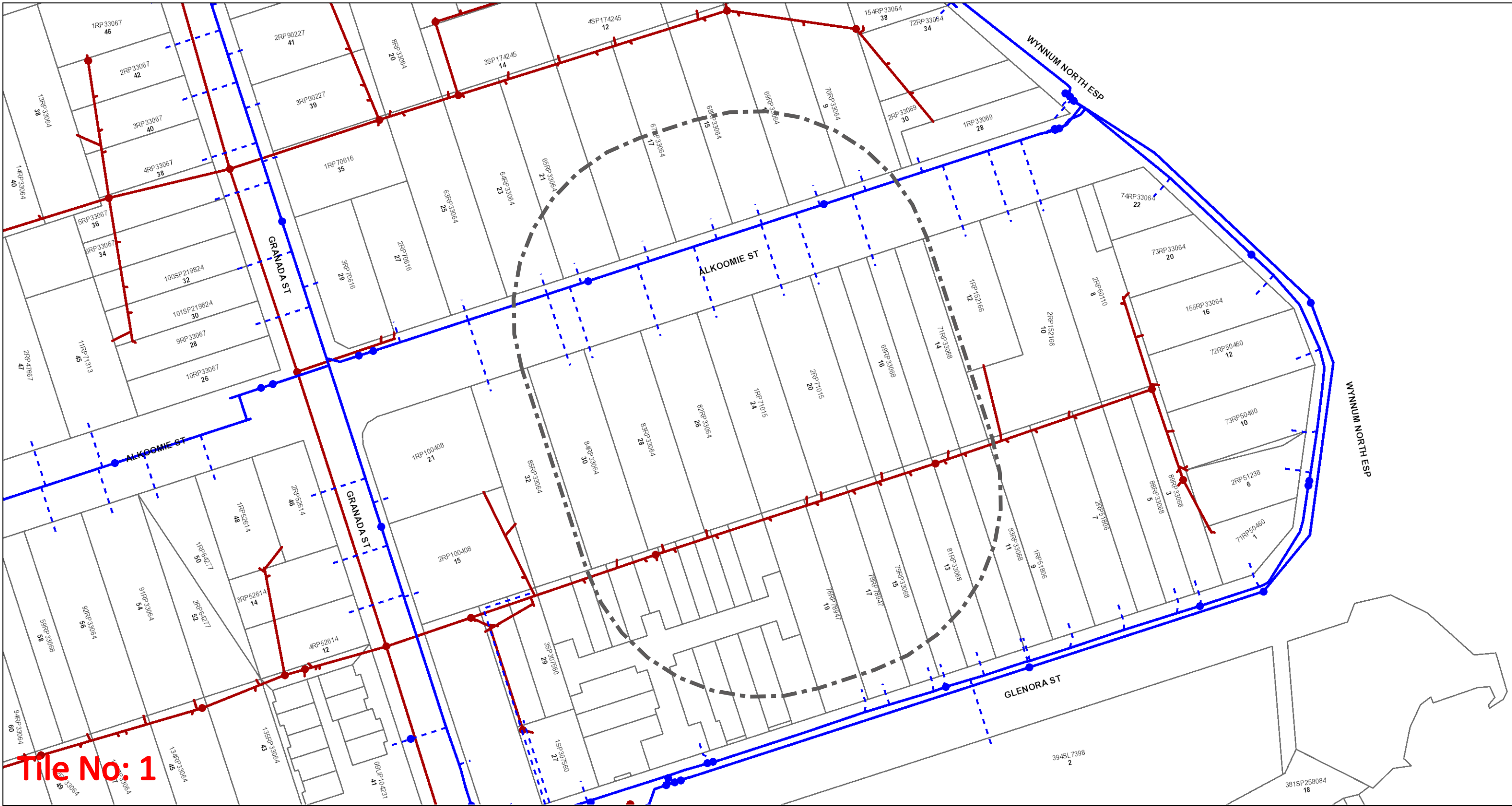

Tile No: 1

 <p>UrbanUtilities</p> <p>N</p> <p>Map Scale 1:1000</p>	<p>Before You Dig Australia- Urban Utilities Water, Recycled Water and Sewer Infrastructure</p> <p>BYDA Reference No: 263708351</p> <p>Date BYDA Ref Received: 05/11/2025 Date BYDA Job to Commence: 05/11/2025 Date BYDA Map Produced: 04/11/2025</p> <p>This Map is valid for 30 days Produced By: Urban Utilities</p>	<table border="0"> <tr> <th>Sewer</th> <th>Water</th> <th>Recycled Water</th> </tr> <tr> <td>● Infrastructure</td> <td>● Infrastructure</td> <td>● Infrastructure</td> </tr> <tr> <td>◆ Major Infrastructure</td> <td>◆ Major Infrastructure</td> <td>◆ Major Infrastructure</td> </tr> <tr> <td>— Network Pipelines</td> <td>— Network Pipelines</td> <td>— Network Pipelines</td> </tr> <tr> <td>▨ Network Structures</td> <td>▨ Network Structures</td> <td>▨ Network Structures</td> </tr> <tr> <td></td> <td>- - - Water Service (Indicative only)</td> <td></td> </tr> </table>	Sewer	Water	Recycled Water	● Infrastructure	● Infrastructure	● Infrastructure	◆ Major Infrastructure	◆ Major Infrastructure	◆ Major Infrastructure	— Network Pipelines	— Network Pipelines	— Network Pipelines	▨ Network Structures	▨ Network Structures	▨ Network Structures		- - - Water Service (Indicative only)		<p>While reasonable measures have been taken to ensure the accuracy of the information contained in this plan response, neither Urban Utilities nor PelicanCorp shall have any liability whatsoever in relation to any loss, damage, cost or expense arising from the use of this plan response or the information contained in it or the completeness or accuracy of such information. Use of such information is subject to and constitutes acceptance of these terms.</p> <p>The plans are indicative and approximate only and provided without warranties of any kind, express or implied including in relation to accuracy, completeness, correctness, currency or fitness for purpose.</p> <p>Urban Utilities takes no responsibility and accepts no liability for any loss, damage, costs or liability that may be incurred by any person acting in reliance on the information provided on the plans.</p> <p>This plan should be used as guide only. Any dimensions should be confirmed on site by the relevant authority.</p> <p>Based on or contains data provided by the State of Queensland (Department of Natural Resources and Mines) [2020]. In consideration of the State permitting the use of this data you acknowledge and agree that the State gives no warranty in relation to the data (including accuracy, liability in negligence) for any loss, damage or costs (including consequential damage) relating to any use of the data. Data must not be used for direct marketing or be used in breach of the privacy laws. © State of Queensland Department of Natural Resources and Mines [2020]</p> <p>For further information, please call Urban Utilities on 13 26 57 (8am-6pm weekdays). Faults and emergencies 13 23 64 (24/7). www.urbanutilities.com.au</p> <p>ABN 86 673 835 011</p>
Sewer	Water	Recycled Water																			
● Infrastructure	● Infrastructure	● Infrastructure																			
◆ Major Infrastructure	◆ Major Infrastructure	◆ Major Infrastructure																			
— Network Pipelines	— Network Pipelines	— Network Pipelines																			
▨ Network Structures	▨ Network Structures	▨ Network Structures																			
	- - - Water Service (Indicative only)																				

Important Information

Disclaimer

All Urban Utilities' records, data and information supplied via BYDA ("**Data**") is **indicative** only. You agree that any Data supplied to you has been or will be provided only for your convenience and has not been and will not be relied upon by you for any purpose.

You also agree that Urban Utilities does not assume any responsibility or duty of care in respect of, or warrant, guarantee or make any representation as to the Data (including its accuracy, reliability, currency or suitability).

Because the location of Urban Utilities' infrastructure shown on the Data is approximate only, you must first physically locate the infrastructure by utilising relevant site detection methodologies prior to performing any works or undertaking any activities near or adjacent to infrastructure. Possible site detection methodologies include hand digging, potholing, trenching and/or probing. You are solely responsible for the selection of appropriate site detection methodologies at all times.

To the fullest extent permitted by law, Urban Utilities will not be liable to you in contract, tort, equity, under statute or otherwise arising from or in connection with the provision of any Data to you via BYDA.

Compliance with laws

There may be both indicated and unmarked hazards, dangers or encumbrances, including underground asbestos pipes and abandoned mains within your nominated search area. You are solely responsible for ensuring that appropriate care is taken at all times and that you comply with all mandatory requirements relating to such matters, including in relation to workplace health and safety.

Damaged Infrastructure

Please note that it is an offence under Section 192 of the *Water Supply (Safety and Reliability) Act 2008* to interfere with our infrastructure without Urban Utilities' written consent.

You may be liable to Urban Utilities for any loss of or damage to our infrastructure, together with any consequential or indirect loss or damage (including without limitation, loss of use, loss of profits or loss of revenue) arising from or in connection with any interference with Urban Utilities' infrastructure by you or any other person for which you are legally responsible.

Any damage to Urban Utilities' Infrastructure must be reported immediately to the (24 Hours) Faults and Emergencies Team on 13 23 64.

Links

Technical Standards: <https://urbanutilities.com.au/development/help-and-advice/standards-and-guidelines>

Copyright

All Data is copyright.

Job ID 51611592

Telstra QLD South East

Referral
263708353

Member Phone
1800 653 935

Responses from this member

Response received Wed 5 Nov 2025 12.07pm

File name	Page
Response Body	76
263708353.pdf	78
AccreditedPlantLocators 2025-09-16a.pdf	79
Telstra Duty of Care v33.0a.pdf	80
Telstra Map Legend v4_0c.pdf	82



Attention: Info Request HPC

Site Location: 24 Alkoomie St, Wynnum, QLD 4178

Your Job Reference: 24 Alkoomie St

Please do not reply to this email, this is an automated message -

Thank you for requesting Telstra information via Before You Dig Australia (BYDA). This response contains Telstra Information relating to your recent request.





 <p>Accredited Plant Locator</p>	<p>General Contact Information including applications required to view Cable Plans - DWF & PDF</p>
 <p>Telstra Duty of Care V32</p>	<p>Your responsibility and Legal requirements working near Telstra's Assets</p>
 <p>Telstra Map Legend 4.0</p>	<p>Common Symbols on Cable Plans and Safe Clearance distances when working near Telstra Assets</p>



Please note:

When working in the vicinity of telecommunications plant you have a 'Duty of Care' that must be observed.

Ensure you read all documents (attached) - they contain important information.

In particular please read and familiarise yourself with the Before you Dig Australia - BEST PRACTISE GUIDES and The five Ps of safe excavation <https://www.byda.com.au/before-you-dig/best-practice-guides/>, as these documents set out the essential steps that must be undertaken prior to commencing construction activities.

 <p>Best practice guides and the five P's of safe excavation</p>	<p>These are the essential steps to be undertaken prior to commencing construction activities</p>	<p>Essential Steps : Link 5 P's: Link</p>
	<p>We highly recommend using certified locators where possible.</p>	<p>CERTLOC : Link</p>
 <p>1800 653 935 Telstra Plan Services</p>	<p>Whenever in doubt please contact this number for Telstra BYDA map related enquiries email Telstra.Plans@team.telstra.com</p>	<p>Note: that Telstra plans are only valid for 60 days from the date of issue</p>
 <p>How to Report Damage to Telstra Equipment</p>	<p>If you think you have damaged Telstra Assets, please Report it ASAP.</p>	<p>Call: 13 22 03 Report Online: Link</p>

	<p>It is a criminal offence under the 'Criminal code act 1995' to tamper or interfere with Telecommunications infrastructure. Telstra will take action to recover compensation for the damage caused to property and assets, and for interference with the operation of Telstra's networks and customer service.</p>
	<p>Telstra plans contain confidential information and are provided on the basis that they are used solely for identifying location or vicinity of Telstra's infrastructure to avoid damage to this infrastructure occurring as part of any digging or other excavation activity. You must not use Telstra's plans for any other purpose or in a way that will cause loss or damage. You must comply with any other terms of access to the data that have been provided by you by Telstra (including conditions of use or access).</p>

WARNING: Telstra plans and location information conform to Quality Level 'D' of the Australian Standard AS 5488 - Classification of Subsurface Utility Information. As such, Telstra supplied location information is indicative only. Spatial accuracy is not applicable to Quality Level D. Refer to AS 5488 for further details. The exact position of Telstra assets can only be validated by physically exposing them. Telstra does not warrant or hold out that its plans are accurate and accepts no responsibility for any inaccuracy. Further on site investigation is required to validate the exact location of Telstra assets prior to commencing work. A Certified Locating Organisation is an essential part of the process to validate the exact location of Telstra assets and to ensure the assets are protected during construction works.

See the **Before You Dig Australia - BEST PRACTISE GUIDES and The five Ps of safe excavation**
[https://www.byda.com.au/before-you-dig/best-practice-guides/..](https://www.byda.com.au/before-you-dig/best-practice-guides/)

Please note that:

- it is a criminal offence under the *Criminal Code Act 1995* (Cth) to tamper or interfere with telecommunications infrastructure.
- Telstra will take action to recover compensation for damage caused to property and assets, and for interference with the operation of Telstra's networks and customers' services.

Telstra's plans contain Telstra's confidential information and are provided on the basis that they are used solely for identifying the location or vicinity of Telstra's infrastructure to avoid damage to this infrastructure occurring as part of any digging or other excavation activity. You must not use Telstra's plans for any other purpose or in a way that will cause Telstra loss or damage and you must comply with any other terms of access to the data that have been provided to you by Telstra (including Conditions of Use or Access).

(See attached file: *Telstra Duty of Care v33.0a.pdf*)

(See attached file: *Telstra Map Legend v4_0c.pdf*)

(See attached file: *AccreditedPlantLocators 2025-09-16a.pdf*)

(See attached file: *263708353.pdf*)



General Information

Before you Dig Australia – BEST PRACTISE GUIDES
<https://www.byda.com.au/before-you-dig/best-practice-guides/>

OPENING ELECTRONIC MAP ATTACHMENTS –

Telstra Cable Plans are generated automatically in either PDF or DWF file types. Dependent on the site address and the size of area selected. You may need to download and install free viewing software from the internet e.g.



DWF Map Files (all sizes over A3)
 Autodesk Viewer (Internet Browser) <https://viewer.autodesk.com/> or
 Autodesk Design Review <http://usa.autodesk.com/design-review/> for DWF files.
 (Windows PC)



PDF Map Files (max size A3)
 Adobe Acrobat Reader <http://get.adobe.com/reader/>



Telstra New Connections / Disconnections
 13 22 00



Telstra Protection & Relocation: 1800 810 443 (AEST business hours only).
[Email](#)
 Telstra Protection & Relocation Fact Sheet: [Link](#)
 Telstra Protection & Relocation Home Page [Link](#)



Telstra Aerial Assets Group (overhead network)
 1800 047 909

Protect our Network:

by maintaining the following distances from our assets:

- **1.0m Mechanical Excavators, Farm Ploughing, Tree Removal**
- **500mm Vibrating Plate or Wacker Packer Compactor**
- **600mm Heavy Vehicle Traffic (over 3 tonnes) not to be driven across Telstra ducts or plant.**
- **1.0m Jackhammers/Pneumatic Breakers**
- **2.0m Boring Equipment (in-line, horizontal and vertical)**

For more info contact a [CERTLOC Certified Locating Organisation \(CLO\)](#) or
Telstra Location Intelligence Team 1800 653 935



Before You Dig Australia

Think before you dig

This document has been sent to you because you requested plans of the Telstra network through Before You Dig Australia (BYDA).

If you are working or excavating near telecommunications cables, or there is a chance that cables are located near your site, you are responsible to avoid causing damage to the Telstra network.

Please read this document carefully. Taking your time now and following the **BYDA's Best Practices and 5 Ps of Safe Excavation** <https://www.byda.com.au/before-you-dig/best-practice-guides/>

can help you avoid damaging our network, interrupting services, and potentially incurring civil and criminal penalties.

Our network is complex and working near it requires expert knowledge. Do not attempt these activities if you are not qualified to do so.



Disclaimer and legal details

*Telstra advises that the accuracy of the information provided by Telstra conforms to Quality Level D as defined in AS5488-2013.

It is a criminal offence under the Criminal Code Act 1995 (Cth) to tamper or interfere with telecommunications infrastructure.

Telstra will also take action to recover costs and damages from persons who damage assets or interfere with the operation of **Telstra's** networks.

By receiving this information including the indicative plans that are provided as part of this information package you confirm that you understand and accept the risks of working near **Telstra's** network and the importance of taking all the necessary steps to confirm the presence, alignments and various depths of **Telstra's** network. This in addition to, and not in replacement of, any duties and obligations you have under applicable law.

When working in the vicinity of a telecommunications plant you have a "Duty of Care" that must be observed. Please read and understand all the information and disclaimers provided below.

The Telstra network is complex and requires expert knowledge to interpret information, to identify and locate components, to pothole underground assets for validation and to safely work around assets without causing damage. If you are not an expert and/or qualified in these areas, then you must not attempt these activities. Telstra will seek compensation for damages caused to its property and losses caused to Telstra and its customers. Construction activities and/or any activities that potentially may impact on Telstra's assets must not commence without first undertaking these steps. Construction activities can include anything that involves breaking ground, potentially affecting Telstra assets.

If you are designing a project, it is recommended that you also undertake these steps to validate underground assets prior to committing to your design.

This Notice has been provided as a guide only and may not provide you with all the information that is required for you to determine what assets are on or near your site of interest. You will also need to collate and understand all information received from other Utilities and understand that some Utilities are not a part of the BYDA program and make your own enquiries as appropriate. It is the responsibility of the entities arranging for the works to be performed, supervising the works, and undertaking the works to protect Telstra network during excavation / construction works.

Telstra owns and retains the copyright in all plans and details provided in conjunction with the applicant's request. The applicant is authorised to use the plans and details only for the purpose indicated in the applicant's request. The applicant must not use the plans or details for any other purpose.

Telstra plans or other details are provided only for the use of the applicant, its servants, agents, or CERTLOC Certified Locating Organisation (CLO). The applicant must not give the plans or details to any parties other than these and must not generate profit from commercialising the plans or details. If the Applicant is aware of another party or parties about to perform or performing works at the location, it should ensure that the other party or parties have lodged a BYDA enquiry and obtained plans for that location. If you are undertaking excavations works you must follow the 5Ps of Safe Excavation. The 5 Ps of Safe Excavation are set out in the video in the below link.

<https://www.byda.com.au/education/resources/>

Telstra, its servants or agents shall not be liable for any loss or damage caused or occasioned by the use of plans and or details so supplied to the applicant, its servants and agents, and the applicant agrees to indemnify Telstra against any claim or demand for any such loss or damage.

Please ensure Telstra plans and information provided always remains on-site throughout the inspection, location, and construction phase of any works.

Telstra plans are valid for 60 days after issue and must be replaced if required after the 60 days.

Data Extraction Fees

In some instances, a data extraction fee may be applicable for the supply of Telstra information. Typically, a data extraction fee may apply to large projects, planning and design requests or requests to be supplied in non-standard formats. For further details contact Telstra Location Intelligence Team.

Telstra does not accept any liability or responsibility for the performance of or advice given by a CERTLOC Certified Locating Organisation (CLO). Certification is an initiative taken by Telstra towards the establishment and maintenance of competency standards. However, performance and the advice given will always depend on the nature of the individual engagement.

Neither the Certified Locating Organisation nor any of its employees are an employee or agent for Telstra. Telstra is not liable for any damage or loss caused by the Certified Locating Organisation or its employees.

Once all work is completed, the excavation should be reinstated with the same type of excavated material unless specified by Telstra.

The information contained within this pamphlet must be used in conjunction with other material supplied as part of this request for information to adequately control the risk of potential asset damage.

When using excavators and other machinery, also check the location of overhead power lines.

Workers and equipment must maintain safety exclusion zones around power lines

WARNING: Telstra plans and location information conform to Quality Level 'D' of the Australian Standard AS 5488 - Classification of Subsurface Utility Information. As such, Telstra supplied location information is indicative only. Spatial accuracy is not applicable to Quality Level D. Refer to AS 5488 for further details. Telstra does not warrant or hold out that its plans are accurate and accepts no responsibility for any inaccuracy shown on the plans. **FURTHER ON SITE INVESTIGATION IS REQUIRED TO VALIDATE THE EXACT LOCATION OF TELSTRA PLANT PRIOR TO COMMENCING CONSTRUCTION WORK.** A plant location service is an essential part of the process to validate the exact location of Telstra assets and to ensure the assets are protected during construction works. The exact position of Telstra assets can only be validated by physically exposing them. Telstra will seek compensation for damages caused to its property and losses caused to Telstra and its customers.

Privacy Note

Your information has been provided to Telstra by BYDA to enable Telstra to respond to your BYDA request. Telstra keeps your information in accordance with its privacy statement. You can obtain a copy at www.telstra.com.au/privacy or by calling us at 1800 039 059 (business hours only).



LEGEND

	Lead-in terminates at a Customer Address
	Exchange Major Cable Present
	Pillar / Cabinet Above ground Free Standing
	Above ground Complex Equipment Please note: Powered by 240v electricity
OC	Other Carrier Telecommunication Cable/ Asset. Not Telstra Owned
DIST	Distribution cables in Main Cable Ducts
MC	Main Cable ducts on a Distribution Plan
	Blocked or Damaged Duct
	Footway Access Chamber (can vary between 1-lid to 12-lid)
	NBN Pillar
	Third Party Owned Network Non-Telstra

	Cable Jointing Pit Number / Letter indicating Pit type/size
	Elevated Joint (above ground joint on buried cable)
	Telstra Plant in shared Utility trench
	Aerial cable / or cable on wall
	Aerial cable (attached to joint use Pole e.g., Power Pole)
	Marker Post Installed
	Buried Transponder
	Marker Post & Transponder
	Optical Fibre Cable Direct Buried
	Direct Buried Cable
	nbn owned network

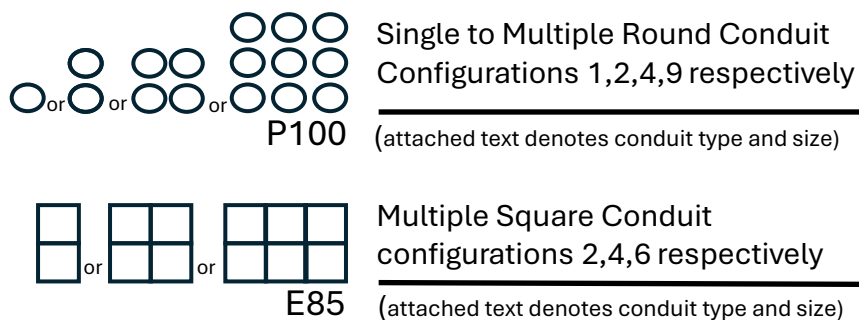

Some examples of conduit type and size:

A - Asbestos cement, P - PVC / Plastic, C - Concrete, GI - Galvanised Iron, E - Earthenware

Conduit sizes nominally range from 20mm to 100mm

P50 50mm PVC conduit
P100 100mm PVC conduit
A100 100mm asbestos cement conduit

Some Examples of how to read Telstra Plans

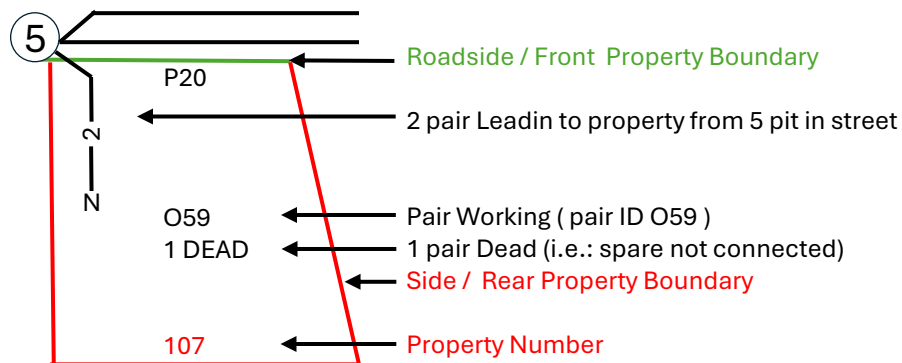
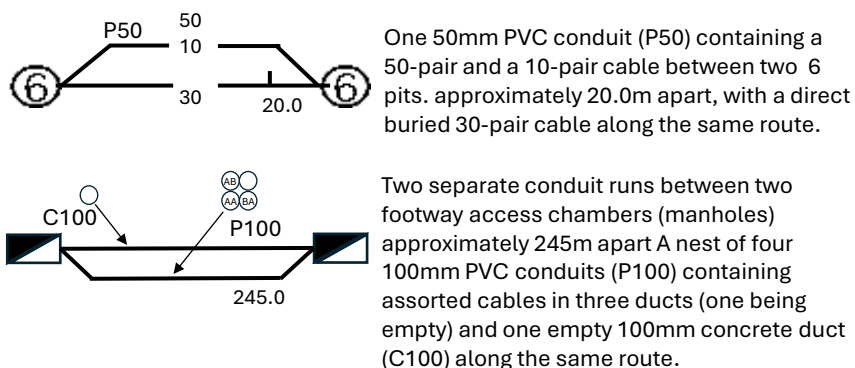

The 5 Ps of Safe Excavation

<https://www.byda.com.au/before-you-dig/best-practice-guides/>

Plan

Plan your job. Use the BYDA service at least one day before your job is due to begin, and ensure you have the correct plans and information required to carry out a safe project.

Prepare

Prepare by communicating with asset owners if you need assistance. Look for clues onsite. Engage a Certified Locator.

Pothole

Potholing is physically sighting the asset by hand digging or hydro vacuum extraction.

Protect

Protecting and supporting the exposed infrastructure is the responsibility of the excavator. Always erect safety barriers in areas of risk and enforce exclusion zones.

Proceed

Only proceed with your excavation work after planning, preparing, potholing (unless prohibited), and having protective measures in place.



End of document

i This document may exclude some files (eg. DWF or ZIP files)

This document was automatically generated at a point-in-time. Be aware that the source information from which this document was created may have changed since it was produced. This document may contain incomplete or out-of-date information. Always check your enquiry details in the BYDA Referral Service for the most recent information. For copyright information refer to individual responses.

Job ID 51611592

24 Alkoomie St



[Review responses online](#) ↗

	<p>Received 5 of 5 responses All responses received</p> <p>24 Alkoomie St, Wynnum QLD 4178</p> <p>Job dates 05/11/2025 → 05/11/2025</p> <p>These plans expire on 3 Dec 2025</p> <p>Lodged by Info Request HPC</p>
--	--

Authority	Status	Page
✉ BYDA Confirmation		2
🏠 APA Group Gas Networks (90073)	Received	4
🏠 Brisbane City Council	Received	56
🏠 NBN Co Qld	Received	59
🏠 Queensland Urban Utilities	Received	70
🏠 Telstra QLD South East	Received	75



Contact Details

Contact Info Request HPC	Contact number (07) 3397 4280	Company -	Enquirer ID 3748544
Email inforequest.hpc@harcourts.com.au	Address 15 Harries Road Coorparoo QLD 4151		

Job Site and Enquiry Details

WARNING: The map below only displays the location of the proposed job site and does not display any asset owners' pipe or cables. The area highlighted has been used only to identify the participating asset owners, who will send information to you directly.

Enquiry date 05/11/2025	Start date 05/11/2025	End date 05/11/2025	On behalf of Private	Job purpose Design	Locations Private	Onsite activities Planning & Design
-----------------------------------	---------------------------------	-------------------------------	--------------------------------	------------------------------	-----------------------------	---



Check that the location of the job site is correct. If not, you must submit a new enquiry.

If the scope of works change or plan validity dates expire, you must submit a new enquiry.

Do NOT dig without plans. Safe excavation is your responsibility. If you don't understand the plans or how to proceed safely, please contact the relevant asset owners.

User Reference 24 Alkoomie St	Address 24 Alkoomie St Wynnum QLD 4178	Notes/description -
---	---	-------------------------------

Your Responsibility and Duty of Care

- **Lodging an enquiry does not authorise project commencement.** Before starting work, you must obtain all necessary information from all affected asset owners.
- If you don't receive plans within 2 business days, contact the asset owner & quote their sequence number.
- Always follow the 5Ps of Safe Excavation (page 2), and locate assets before commencing work.
- Ensure you comply with State legislative requirements for Duty of Care and safe digging.
- If you damage an underground asset, you MUST advise the asset owner immediately.
- By using the BYDA service, you agree to the [Privacy Policy](#) and [Term of Use](#).
- For more information on safe digging practices, visit www.byda.com.au

Asset Owner Details

Below is a list of asset owners with underground infrastructure in and around your job site. It is your responsibility to identify the presence of these assets. Plans issued by Members are indicative only unless specified otherwise. Note: not all asset owners are registered with BYDA. You must contact asset owners not listed here directly.

Referral ID (Seq. no)	Authority Name	Phone	Status
263708352	APA Group Gas Networks (90073)	1800 085 628	NOTIFIED
263708350	Brisbane City Council	(07) 3403 8888	NOTIFIED
263708349	NBN Co Qld	1800 687 626	NOTIFIED
263708351	Queensland Urban Utilities	13 26 57	NOTIFIED
263708353	Telstra QLD South East	1800 653 935	NOTIFIED

END OF UTILITIES LIST



Plan

Plan your job. Use the BYDA service at least one day before your job is due to begin, and ensure you have the correct plans and information required to carry out a safe project.



Prepare

Prepare by communicating with asset owners if you need assistance. Look for clues onsite. Engage a skilled Locator.



Pothole

Potholing is physically sighting the asset by hand digging or hydro vacuum extraction.



Protect

Protecting and supporting the exposed infrastructure is the responsibility of the excavator. Always erect safety barriers in areas of risk and enforce exclusion zones.



Proceed

Only proceed with your excavation work after planning, preparing, potholing (unless prohibited), and having protective measures in place.

Engage a skilled Locator

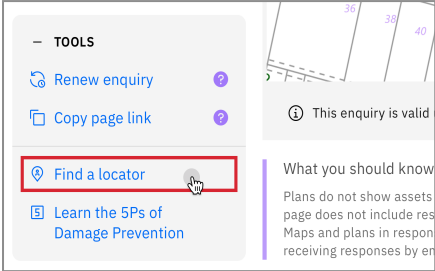

When you lodge an enquiry you will see skilled Locators to contact

Visit the Certified Locator website directly and search for a locator near you

certloc.com.au/locators

Get FREE Quotes for Contractors & Equipment Fast



Use iseekplant's FREE marketplace to get quotes for the equipment or services you need on your project. Compare quotes from trusted local contractors and get your project done on time and in budget.

1. Fill out your job details in our FREE quick quote form.
2. We send the request to trusted local contractors.
3. The local contractors will contact you directly with quotes

GET QUOTE

Use iseekplant to find trusted contractors near you today, visit: blog.iseekplant.com.au/byda-isp-get-quotes

Book a FREE BYDA Session



BYDA offers free training sessions to suit you and your organisation's needs covering safe work practices when working near essential infrastructure assets. The free sessions are offered in two different formats - online and face-to-face.

To book a session, visit: byda.com.au/contact/education-awareness-enquiry-form

BOOK NOW

Job ID 51611592

APA Group Gas Networks (90073)

Referral
263708352

Member Phone
1800 085 628

Responses from this member

Response received Wed 5 Nov 2025 11.55am

File name	Page
Response Body	5
263708352.pdf	6
400-STD-AM-0001_2 Guidelines for Works Near Existing Gas Assets.pdf	15

PLEASE NOTE: This is an automated response. Please **DO NOT REPLY to this email.** If you require further information in relation to this Before You Dig response, please contact

BYDA_APA@apa.com.au

Enquiry Details:

Impact	affected
Sequence Number	263708352
Enquirer Id	3748544
Activity	Planning and Design
Job Number	51611592
User Reference	24 Alkoomie St
Message	

Site Details:

Address	24 Alkoomie St Wynnum QLD 4178
---------	--------------------------------------

Enquirers Details:

Contact	Info Request HPC
Company	
Email	inforequest.hpc@harcourts.com.au
Phone	+61733974280
Address	15 Harries Road Coorparoo QLD 4151

APA Group

APA

Australia's energy
infrastructure partner



Before You Dig Australia

Classification: Networks

Enquiry date	05/11/2025
Sequence number	263708352
Work site address	24 Alkoomie St Wynnum QLD 4178



**For your immediate information****THERE IS A GAS PIPELINE OR INFRASTRUCTURE ASSETS
(GAS ASSETS)****located in close vicinity to your works.**

Enquiry Date: 05/11/2025
Enquirer: Info Request HPC
Sequence Number: 263708352
Work Site Address: 24 Alkoomie St
Wynnum
QLD 4178

Thank you for your Before You Dig enquiry regarding the location of gas assets.

We confirm there are Gas Assets located in close vicinity of the above location.

Caution: Damage to gas assets may result in explosion, fire and personal injury.

Please ensure you read all the relevant information contained in this response to your BYDA enquiry including reviewing the **APA Guidelines for Works Near Existing Gas Assets** and clearly understand and comply with all requirements relating to your scope of work.

If you have any queries relating to this information, or you are unable to comply with requirements of the APA Guidelines for Works Near Existing Gas Assets contact the APA Before You Dig Officer

- Phone 1800 085 628
- Email BYDA_APA@apa.com.au

for clarification before proceeding with any work.

Before You Dig Checklist



1. Plan

- Review maps provided with this BYDA response and confirm the location of your work site is correct.
 - Review the **APA Guidelines for Works Near Existing Gas Assets** and clearly understand requirements relating to my scope of work.
-



2. Prepare

- Electronically locate gas assets and mark locations.
 - Note: Look for visible evidence of gas assets at the worksite which may not be shown on plans.
-



3. Pothole

- Physically confirm ('prove') the location of gas assets by potholing by hand excavation or non-destructive vacuum excavation methods in accordance with **APA Guidelines for Works Near Existing Gas Assets**.
 - Road authorities, councils, utilities and their authorised contractors and agents are responsible to pothole or use other suitable methods to verify the location and depth of all gas assets, including gas (inlet) services, prior to commencing any works.
-



4. Protect

- Protect gas assets by maintaining clearances whilst excavating and following conditions provided by APA.
 - Where required by APA, only conducting work in proximity to gas assets while Site Watch is on site.
 - Where applicable, APA Authority To Work permit conditions are clearly understood and complied with.
 - Strap and support exposed mains and inlet services. Cover exposed mains to prevent damage until the excavation can be permanently restored.
-



5. Proceed

- Only proceed with your work once you have completed all the planning, preparation, potholing and protection requirements.
 - APA BYDA response (including maps) are on site for reference at all times, and less than 30 days old.
-

Contacts

Contacts APA Group	
Enquiry	Contact Numbers
General enquiries or feedback regarding this information or gas assets.	APA – Before You Dig Officer Phone: 1800 085 628 Email: BYDA_APA@apa.com.au
Gas Emergencies	Phone: 1800 GAS LEAK (1800 427 532)

Site Watch

Site Watch is where an APA field officer attends your work site to monitor and ensure controls are in place to protect critical gas assets from damage during work.

The following rates apply for this service (1 hour minimum charge):

Item	Rate (excl. gst)
Site Watch – Business Hours	\$143.42 per hour
Site Watch – After Hours	\$175.06 per hour
Cancellation Fee	\$286.84
<i>Fee applies where cancellations received after 12pm (midday), 1 business day prior to the booking.</i>	

Contact APA – Before You Dig officer for state specific hours of business.

Site 24 Alkoomie St
Address: Wynnum
QLD 4178

Sequence 263708352
Number:

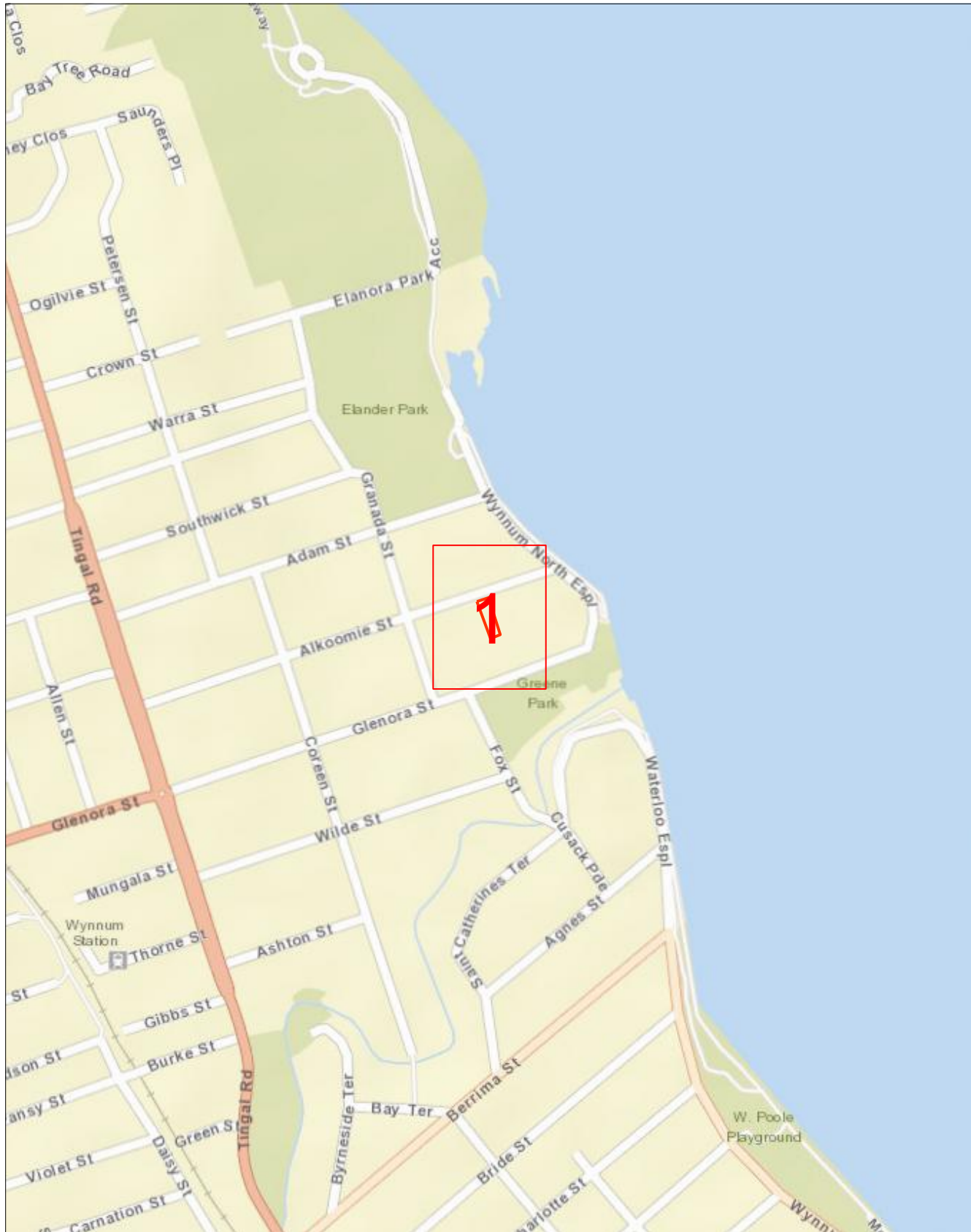

Scale 1: 6000

Map Sources: Esri, Garmin, HERE, FAO, NOAA, USGS,
© OpenStreetMap contributors, and the GIS User Community



Enquiry Area



Map Key Area



Site 24 Alkoomie St
Address: Wynnum
QLD 4178

Sequence 263708352
Number:



Scale 1: 700

Map Sources: Esri, Garmin, HERE, FAO, NOAA, USGS,
© OpenStreetMap contributors, and the GIS User Community



Enquiry Area



Map Key Area



Legend

<p>Pipe</p> <p>Low pressure </p> <p>Medium pressure </p> <p>High pressure </p> <p>Transmission pressure </p> <p>Critical main (behind pipe) </p> <p>Proposed (pressure by colour) </p> <p>LPG (pressure by colour) </p> <p>Hydrogen blended (pressure by colour) </p> <p>Abandoned </p> <p>Idle/inactive </p> <p>Sleeve </p> <p>Casing (behind pipe) </p>	<p>Pipe code and material</p> <p>C* (for example, C2) Cast iron</p> <p>CU Copper</p> <p>N2 Nylon</p> <p>P* Polyethylene (PE)</p> <p>P3 Polyvinyl chloride (PVC)</p> <p>P6, P7, P9-P12 Medium density PE</p> <p>P2, P4, P8 High density PE</p> <p>S* Steel</p> <p>W2 Wrought galv iron</p> <p>W3 PE coat wrought galv iron</p>	<p>Object</p> <p>Valve </p> <p>Buried valve </p> <p>Regulator </p> <p>Gas supplied = yes </p> <p>CP rectifier terminal </p> <p>CP test station </p> <p>CP anode </p> <p>CP bond wire </p> <p>Syphon </p> <p>Trace wire point </p>
<p>Area</p> <p>BYDA area of interest </p>	<p>Abbreviation</p> <p>BoK Back of kerb</p> <p>C Depth of cover</p> <p>CP Cathodic protection</p> <p>FoK Front of kerb</p> <p>Galv Galvanized</p> <p>NTI Not tied in</p>	
<p>Example</p>		
<p>Pipe</p> <p> 40P6 in 80C2</p> <p> 63S8</p>	<p>40 mm high pressure medium density poly in an 80 mm cast iron casing</p> <p>63 mm medium pressure steel</p>	<p>Pipe code</p> <p>Pipe diameter in millimetres is shown before pipe code.</p> <p>40P6 = 40 mm nominal diameter</p>

This map was created in colour and should be printed in colour

Important information

- Refer to requirements relating to construction, excavation and other work activities in the **APA Guidelines for Works Near Existing Gas Assets** document with this BYDA response.
- BYDA enquiries are valid for 30 days. If your works commence after 30 days from the date of this response a new enquiry is required to validate location information.
- For some BYDA enquiries, you may receive two (2) responses from APA. Please read both responses carefully as they relate to different assets.
- Gas (inlet) services connecting Gas Assets in the street to the gas meter on the property are not marked on the map. South Australia Only – if a meter box is installed on the property, a sketch of the gas service location may be found inside the gas meter box. APA does not guarantee the accuracy or completeness of these sketches.

Free Gas Pipeline Awareness Training and Information

PROFESSIONALS

APA offers online and in-person toolbox forums to support safe work near underground gas assets. Topics include distribution and transmission pipelines, the permit process, and gas emergencies, with content suited for companies of all sizes. A Continuing Professional Development certificate is available upon completion.

Scan the QR code to register for an online toolbox, or email damageprevention@apa.com.au to request an in-person presentation.

HOMEOWNERS

If you're working near your home's gas pipes stay safe and view APA's video guide '**Working Safely Near Gas Lines: A DIY Homeowner's Guide**' which offers simple tips to avoid damaging gas pipes.

Scan the QR code to view the video, or for more information email damageprevention@apa.com.au



Disclaimer and legal details

- This information is valid for 30 days from the date of this response.
- This information has been generated by an automated system based on the area highlighted in your BYDA request and has not been independently verified.
- Map location information is provided as AS5488-2022 Quality Level D, as such supplied location information is indicative only.
- Whilst APA has taken reasonable steps to ensure that the information supplied is accurate, the information is provided strictly on the condition that no assurance, representation, warranty or guarantee (express or implied) is given by APA in relation to the information (including without limitation quality, accuracy, reliability, completeness, currency, sustainability, or suitability for any particular purpose) except that the information has been disclosed in good faith.
- Any party who undertakes activities in the vicinity of APA operated assets has a legal duty of care that must be observed. This legal obligation requires all parties to adhere to a standard of reasonable care while performing any acts that could foreseeably harm these assets.



APA
Australia's energy
infrastructure partner



Guidelines for Works Near Existing Gas Assets

400-STD-AM-0001

Revision 2

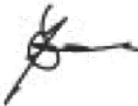
OWNER NAME:	Alan Creffield
OWNER TITLE:	Manager of Integrity
APPROVER NAME:	Anastasia Coutie
APPROVER TITLE:	Team Lead – 3 rd Party Engagement
APPROVAL SIGNATURE:	
APPROVAL DATE:	18/08/2023

always powering ahead



DOCUMENT CONTROL & APPROVAL INFORMATION

Summary of Changes

Below is a brief summary of the changes made to the document since the previous issued version.

Revision	Description	Date	Author
0.0	Issue for Use	29.06.2018	Matthew Read
1.0	Issued for Use – document periodic update / major overhaul	01.03.2022	Kahil Parsons
2.0	Removal of incorrect table 2 references to 1. proximity of HV cables 2. Updating separation distances to AS2885.3 BYDA reference update Table 4 Note	16.08.2023	Dale Russell

Printed Working Copy

All printed copies of this document are to be used as reference copies only.

It is the responsibility of those with printed copies to ensure that the document is current.

Responsibility

Any amendments to this document will be the responsibility of the document owner.

Control

Controlled Networks documents including templates are published on the Networks National Document Library (NNDL).

All native copies of published controlled Networks documents are managed by NetworksDocLibrary@apa.com.au in accordance with 400-PR-QM-0001, Networks Controlled Documents Development and Review procedure.



Table of Contents

DOCUMENT CONTROL & APPROVAL INFORMATION	2
Summary of Changes	2
Printed Working Copy	2
Responsibility	2
Control.....	2
TERMS OF USE	5
1 INTRODUCTION.....	6
1.1 Scope of this Document	6
1.2 Asset Types.....	6
1.2.1 Natural Gas Transmission	6
1.2.2 Natural Gas Distribution	7
1.2.3 LPG Distribution	7
1.3 Damage and Emergencies.....	7
1.4 General Duty of Care and Responsibility to Obtain Information	8
1.4.1 Additional Transmission Pressure Pipeline Requirements	8
2 PROTECTION PROCESS	9
2.1 Assessment Information	9
3 PART 1 - APA NOTIFICATION AND AUTHORISATION REQUIREMENTS	11
3.1 BYDA Request	11
3.2 Provings and Site Identification	11
3.3 APA Notification and Authorisation Process	11
3.4 Commercial Agreement and Service Delivery	13
3.5 Decommissioned Gas Assets	13
4 PART 2 - DESIGN AND ASSET PROTECTION REQUIREMENTS	15
4.1 Standard Clearances.....	15
4.2 Third Party Assets and Structures.....	19
4.3 Landscaping Plans	19
4.4 Surface Levels and Conditions.....	21
4.5 Casings Vent Stacks	22
4.6 Earthing and Electrical Effects	23
4.7 Temporary and Permanent Vehicle Crossings	24
5 PART 3 - CONSTRUCTION AND LAND USE REQUIREMENTS	25
5.1 Land Use Change.....	25
5.2 Permits and Site Watch.....	25
5.3 Coating Surveys and Leakage Surveys	26
5.4 Pipeline Repairs, Recoating and Slabbing.....	26
5.5 Exposure of Buried Gas Assets	27
5.5.1 General.....	27



Guidelines for Works Near Existing Gas Assets
400-STD-AM-0001 Revision 2

5.5.2	Physically Proving Gas Assets	27
5.5.3	Hydro-Vacuum Excavation	28
5.5.4	Mechanical Excavation	29
5.5.6	Protection During Exposure	30
5.5.7	Backfill and Reinstatement	31
5.6	Trenchless Excavation	31
5.7	Piles, Piers or Poles	32
5.8	Hot Works for Construction Activities	32
5.9	Vibration Limits	32
5.10	Compaction Limits	33
5.11	Blasting / Seismic Survey / Explosives.....	33
5.12	Suspended Materials above Gas Assets and No Go Zones for Cranes	34
5.13	Temporary Materials.....	34
6	PART 4 - ALTERATION OF EXISTING GAS ASSETS.....	34
7	GLOSSARY OF TERMS AND ABBREVIATIONS	35
8	DOCUMENT REFERENCES.....	40
APPENDIX A GENERAL BYDA RESPONSE PROCESS		41



TERMS OF USE

The “Guidelines for Works Near Existing Gas Assets Standard” is used for APA Networks excavations or third party excavations near APA Network operated assets. This guideline must only be used by the person or entity who received it directly from APA (“You”) to ensure the latest version is used.

APA Networks has provided this document to You subject to the terms of use set out below. By retaining possession of this document, You acknowledge and agree to the following conditions;

1. The information contained in this document relates only to APA Networks operated assets (as defined in this document) and does not relate to any other utility assets owned or operated by APA, such as APA Gas Transmission Pipelines.
2. This Guidelines document is provided to You to assist in the development of design plans, construction and land use activities.
3. This Guidelines document does not override or supersede APA’s Permit to Work (**PTW**) or Excavation policies and procedures.
4. Any proposed works in the vicinity of APA Networks operated assets may also require approval from other utility providers or government agencies. APA Networks has no responsibility for, and makes no representation in relation to, any requirements that may be necessary to obtain such approvals.
5. This document does not relieve any person from the requirement to make appropriate Before You Dig Australia (**BYDA**) enquiries, and otherwise discuss any proposed works with APA Networks, either for initial or subsequent works.
6. You must not reproduce this document without APA Networks permission and must not alter or amend this document.
7. To ensure the latest version of this document is used only APA Networks can provide a valid copy of this document.
8. APA Networks reserves its right to modify, amend, supplement, delete or withdraw any part of this document or any reference contained in this document, at any time without notice.
9. You must make your own independent enquiries in relation to any works that are proposed to be undertaken in the vicinity of any APA Networks operated assets (including obtaining all necessary express written consents and approvals from APA Networks). The information contained within is intended as a guide only.
10. Except as required by law and only to the extent so required, APA Networks and its related bodies corporate, officers, employees, agents and Contractors;
 - a) do not make any representation, warranty or undertaking, express or implied, as to, or accept any responsibility or liability for; and
 - b) are not in any way liable, directly or indirectly, to You or any other person for any loss, damages, costs, expenses or reliance arising out of or in connection with the validity, accuracy, completeness, relevance, or any errors in or omissions from, any information or statement contained in this document.
11. APA Networks reserves all its rights in the information contained in this document. No rights or obligations are granted or to be implied from the contents of this document. You acknowledge that all intellectual property and other tangible and intangible rights in the information contained in this document are and remain the exclusive property of APA Networks.
12. You agree to release and indemnify APA Networks and its related bodies corporate, officers, employees, agents and Contractors against all reasonably foreseeable claims, costs, expenses, losses and liabilities (including legal costs on a full indemnity basis) suffered or incurred by them as a result or in connection with the use of this document by You.

The purpose of this document is to provide guidelines for third parties planning to install new infrastructure or conduct works near existing APA Networks (**APA**) operated assets.

It is intended that this document will be provided to third parties proposing works around existing gas assets for their use during the design and planning phase following initial planning BYDA enquiries. This document does not provide authorisation to undertake the works but provides APA requirements to ensure that any review and acceptance of proposed works is completed as quickly as possible.

1 INTRODUCTION

1.1 Scope of this Document

This document addresses APA’s requirements for considering how a third party’s proposed works and APA managed works may impact APA Networks operated assets under the following parts:

Part 1 – APA Notification and Authorisation Requirements

Part 2 – Design and Asset Protection Requirements

Part 3 – Construction and Land Use Requirements

Part 4 – Alteration of Existing Gas Assets

APA Networks acts as the asset operator on behalf of entities Australian Gas Networks (**AGN**), Allgas, APA, Origin and Queensland Nitrates (**QNP**) and operates in New South Wales, Northern Territory, Queensland, South Australia and Victoria. The criteria provided in this document only applies to the assets managed by APA Networks on behalf of these companies.

APA also owns and operates natural gas transmission infrastructure on all mainland states and territories of Australia. These assets are operated by a separate APA entity and are out of scope for this document.

A glossary of all terms and abbreviations used in this document is contained in **Section 7**.

A list of all relevant external standards and APA reference documents is contained in **Section 8**.

1.2 Asset Types

APA Networks’ operated gas assets include buried pipe, above and below ground stations (e.g. pressure regulation, valves, meters), electrical cables, cathodic protection systems (e.g. test points, anode beds), pits and electrical cabinets. Depending on the gas type and the operating pressure, gas assets are classified as natural gas transmission, natural gas distribution and Liquefied Petroleum Gas (**LPG**) distribution as shown in **Figure 1**.

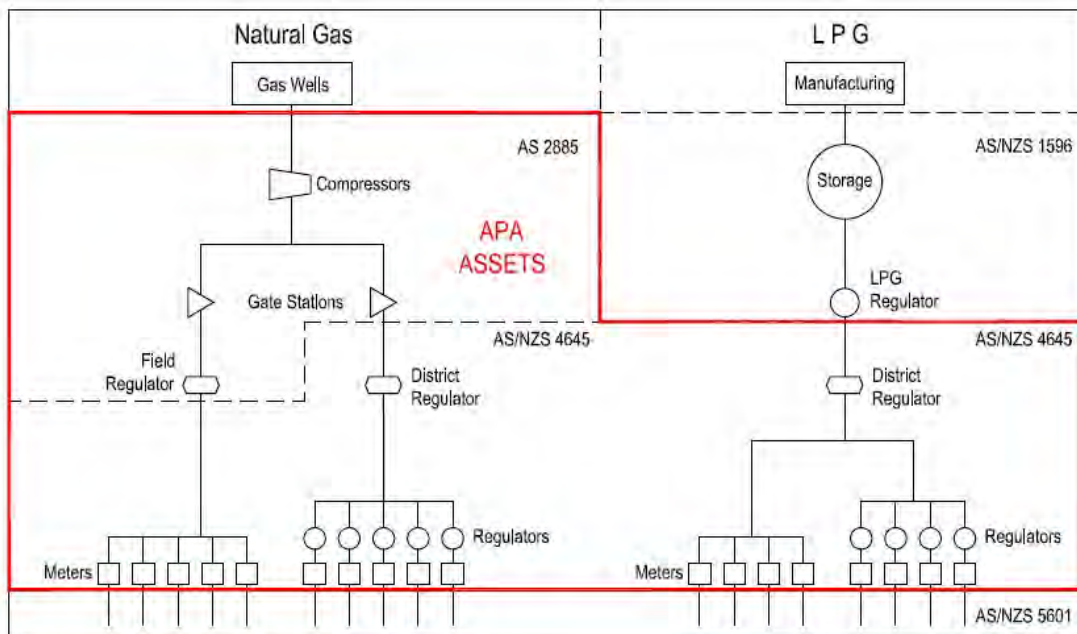

Figure 1 Asset Types and Standards Operated by APA Networks

1.2.1 Natural Gas Transmission

Natural gas transmission pressure assets operate at pressures above 1,050 kPag, and are generally used for transporting large quantities of gas across country. Design, construction and operation of these assets is governed by the AS 2885 suite of Australian Standards (**AS**).

Due to the higher pressure and energy density, there are severe safety, supply and environmental consequences which can result from third party interference. Hence, more stringent requirements and controls are applied to third party works in the vicinity of these assets.



Buried transmission pipelines are constructed from coated steel pipe where the appearance can vary depending on the year of construction, but will generally appear as yellow, black or grey when physically exposed.

1.2.2 Natural Gas Distribution

Natural gas distribution pressure assets operate at pressures below or equal to 1,050 kPag from offtakes of transmission pressure assets, and are generally used to supply consumers such as businesses and homes. Design, construction and operation of these assets is governed by the AS/NZS 4645 suite of Australian Standards.

Due to the lower energy density compared to transmission assets, less stringent requirements and controls are applied to distribution assets. Some distribution assets are deemed critical by APA Networks due to the safety and supply implications that may arise due to a third party strike. These critical distribution assets will be defined on BYDA responses, and some of the controls which are applied to transmission pressure assets (e.g. permit and site watch) will be required.

Buried distribution pressure pipes may be constructed from the following materials and physical appearances when exposed:

- Cast Iron (black);
- Polyethylene (PE) (yellow or black with yellow stripes);
- Steel coated or uncoated (generally yellow, black or grey); and
- Other plastic such as Polyvinyl Chloride (PVC) or nylon (yellow).

Some legacy materials such as cast iron and nylon may require additional protection during construction works due to the unpredictable nature of the materials.

1.2.3 LPG Distribution

LPG distribution pressure assets operate at pressures below 140 kPag from storage compounds and are generally used to supply consumers such as businesses and homes in parts of Queensland, South Australia and Northern Territory. Design, construction and operation of these assets is governed by the AS/NZS 4645 suite of Australian Standards.

Additional safety considerations are required in addition to the requirements for natural gas, as LPG is heavier than air and will pool at the leak point and can accumulate in a trench or excavation.

The same materials used for buried distribution pressure pipes (**Section 1.2.2**) may be used on LPG distribution networks.

1.3 Damage and Emergencies

If you smell gas or damage has occurred, or is suspected, on any gas asset call APA emergency number **1800 GAS LEAK (1800 427 532) or 1800 808 526 for LPG assets.**

Any unreported damage has the potential to escalate and endanger public safety.

Where damage has resulted in a release of gas, you are advised to take the following immediate action:

- Clear the area of all people. Do not under any circumstance re-enter the damage area;
- Where safe to do so, shut off or remove all ignition sources and devices in the area e.g. naked flames, vehicle engines, power tools, mobile phones;
- Do not attempt to stop the flow or repair the damage;
- Allow the gas to vent to air; and
- Once clear of the area, contact the emergency number **1800 427 532** or **1800 808 526 for LPG assets.**

The conditions in this document or as provided by APA Networks are intended to protect the gas assets as well as keep safe any construction crews or general public in the vicinity. Depending on the circumstances, some variation to the conditions in this document may be required or may be provided by an approved APA Networks site watch representative. It is legislated in all jurisdictions that the direction provided by APA is followed.



1.4 General Duty of Care and Responsibility to Obtain Information

Anybody working near a gas asset, or responsible for such work, has a duty of care to exercise caution, to maintain a safe working environment and to meet requirements of all relevant laws and Occupational Health and Safety legislation.

For general enquiries about results from BYDA please contact:

- DBYDNetworksAPA@apa.com.au for Northern Territory, South Australia, Southern New South Wales and Victoria, and;
- PermitsQLD@apa.com.au for Queensland and Northern NSW (incl. Tamworth).

The third party shall make contact with APA through the BYDA process if any clarification is required to determine the approval processes for any proposed land use changes (within the Measurement Length), design works and construction activities within 3 m of a gas asset or within a pipeline easement.

Any works proposed by the third party will only be authorised if APA is satisfied that the works will not affect the integrity of the APA Networks operated assets.

Any person undertaking work near an APA Networks operated asset, or responsible for such work, must ensure that they familiarise themselves with APA requirements.

Working around any gas asset, especially transmission pressure pipelines, without appropriate planning and controls as specified by APA Networks can be extremely dangerous. Damage to a gas asset could result in:

- Possible explosion and fire with the risk of loss of equipment, property, personal injury, and death;
- Loss of gas supply to thousands of customers;
- Substantial repair and gas restoration liability costs to the authority or principal responsible; and,
- Prosecution under the relevant laws governing pipeline and gas safety.

Prior to the commencement of any works within the Protected Zone of transmission pressure or critical gas assets, the Contractor performing the work must receive an Authority to Work Permit (ATWP).

Any works within the Protected Zone of critical assets must comply with any conditions attached to an ATWP and depending upon the nature of the asset and works supported by an approved construction methodology.

Written authorisation in the form of the ATWP must be kept on site at all times, and the holder of the authorisation must comply with all the conditions of the ATWP. The performance of any works near critical APA Networks operated assets without a valid ATWP and full compliance with its conditions will constitute a safety incident and may also result in an infringement notice and associated penalties issued by the regulator of the APA Networks asset.

1.4.1 Additional Transmission Pressure Pipeline Requirements

Where the works proposed by the third party may result in a change in land use within the Measurement Length for a transmission pressure pipeline (as defined in AS/NZS 2885.6 for Pipelines – Gas and Liquid Petroleum), such works may also be subject to formal approval requirements through APA Networks and applicable local and state government planning processes. This may also require a Safety Management Study (**SMS**) Report to be completed and approved by APA Networks. The SMS Report is generated from an SMS workshop involving an SMS facilitator, the third party and APA Networks. APA Networks is the owner of the SMS Report and any resulting recommendations/ actions must be implemented to the satisfaction of APA prior to the commencement of any physical works.

Certain categories of development/ land use change are not appropriate to be located within the Measurement Length of transmission pressure pipelines. In certain circumstances, the otherwise unacceptable risks associated with such developments may be alleviated with the aid of installing protective slabbing over the asset or undertaking other protection and mitigation measures.



2 PROTECTION PROCESS

APA is committed to working cooperatively with third parties to ensure that existing gas assets will be appropriately protected from any proposed works.

The process to be followed for any proposed works is outlined in **Table 1**. This table cross references the relevant section of this document which provides any specific requirements for each gas asset classification. The steps in this table are to be followed in conjunction with the process outlined by BYDA¹, a flow chart is also provided in **APPENDIX A**.

Table 1 Protection Process Summary

Section	Step	Purpose
3	Notification and Authorisation	<p>Identify and locate existing gas assets in the vicinity of any proposed works.</p> <p>Submit BYDA requests to obtain indicative plans of gas assets.</p> <p>Notify APA Networks and obtain approval to verify the exact position by physically proving the position of gas assets at the cost of the third party.</p>
4	Design and Protection Requirements	<p>Review APA Networks design and protection requirements for any proposed infrastructure near gas assets.</p> <p>If acceptable clearance is available in accordance with this section review impact of construction methodology on existing gas assets.</p> <p>If acceptable clearance is not available in accordance with this section and the proposed infrastructure cannot be modified, alteration or protection of the existing gas assets will be required at the cost of the third party.</p>
5	Construction and Land Use Requirements	<p>Review construction methodology for adverse impact to existing gas assets.</p> <p>Some additional protection measures may be required depending on the existing gas assets, the construction methodology and whether land use changes are required.</p> <p>If works meet the requirements of this document, submit work package to APA Networks for review and approval. If approval is given, then undertake works in accordance with APA Networks conditions/ permits. If approval is not given modify work package accordingly.</p> <p>If works do not meet the requirements of this document or APA Networks approval cannot be reached, alteration or protection of the existing gas assets will be required.</p>
6	Alteration	<p>Request alteration of existing gas infrastructure if there is insufficient clearance or construction methods will adversely impact existing gas assets.</p> <p>Alteration of existing gas assets are fully recoverable and may result in delays if not identified early.</p>

2.1 Assessment Information

Throughout the protection process, APA Networks assessment may be required to determine if the proposed works/ installation has sufficient separation or if work can be undertaken with a suitable construction methodology. If APA Networks assessment is required, the following information must be provided to enable an efficient and comprehensive review.

- Due dates or a work program;
- The location / address and extent of proposed works;

¹ BYDA process is available at <https://www.1100.com.au/safety-information/digging-safely/>

Guidelines for Works Near Existing Gas Assets
400-STD-AM-0001 Revision 2



- Scope / description of the work impacting APA assets;
- A work package containing detailed design or construction issue drawings with the location of APA assets and the extent of works marked and / or georeferenced. Sufficient details must be provided on the plans to verify locations against APA information, which is typically measured from property boundaries. Plan and cross sectional drawings are typically required, including any proving locations;
- The proposed construction methodology (if available); and
- For critical assets only, a completed permit request form. This form is automatically provided in response to a BYDA enquiry when it is required, with direction for this form included in the BYDA response (refer to **Section 5.2**).

If the information provided is incomplete, or irrelevant information is provided, it may result in a delay of the assessment process and provision of a response. Due to the varying nature of potential works, it is not possible to develop a comprehensive listing of information that will be required for each work type, but the above is provided as a general guideline for what will normally be required.



3 PART 1 - APA NOTIFICATION AND AUTHORISATION REQUIREMENTS

3.1 BYDA Request

The fastest method for obtaining APA Network gas asset locations is to lodge a BYDA request. A response can be expected from APA within two business days, and may include one of three responses as outlined in **APPENDIX A**, depending on the location of the works in relation to existing APA operated gas assets in the vicinity.

For some BYDA requests, APA Networks may provide different responses to different assets affected by the proposed works. In all instances it is the responsibility of the third party to review and follow the direction of all BYDA responses.

The information provided by APA Networks in response to a BYDA request, along with any other plans or subsequent information provided by APA, show only the indicative location of the asset at the time and are a guide only. In most instances it will be necessary to prove the location of all buried assets within the proposed work area.

The following items must be considered when using asset information provided by APA Networks:

- Gas service lines from buried distribution pressure supply mains to consumers may not be shown on plans. Service lines are usually laid at right angles from main to a meter position, except where road conduits are provided; and
- Plans become rapidly outdated and so should be used within 30 days and then destroyed. It is the responsibility of the third party to contact APA Networks to seek the updated or renewal of any information after this time.

APA shall not be liable or responsible for the accuracy of any information supplied.

3.2 Provings and Site Identification

Electronic location (e.g. ground penetrating radar, pipe locators) of gas assets is required to verify the onsite locations and any plans that have been provided.

Physical proving of existing gas assets is required at key locations to verify that the separation and protection criteria provided in this document have been achieved. The location and quantity of provings will depend on the scope of proposed work, but provings will at least be required at infrastructure crossing points or where changes to surface level condition are planned.

Additional verifications are required for works parallel and in close vicinity to existing gas assets. Physical provings at maximum 10 m intervals along straight sections of pipe, along with all bends, branch lines and customer service offtakes to verify asset locations.

Note: Live service offtakes which no longer supply consumers may protrude from the gas asset and are not traceable or identifiable from records.

Note: The maximum physical proving intervals for straight sections of pipe may be adjusted based upon the discretion of APA personnel for extenuating circumstances.

The following items must be considered when proving the location of an existing gas asset:

- Provings must be conducted safely and in accordance with the requirements of **Section 5.5.2**. If damage to a gas asset does occur it should be reported immediately to APA as described in **Section 1.3**.
- Permit and site watch by an APA Networks representative may be required for some proving activities in accordance with **Section 5.2**.

3.3 APA Notification and Authorisation Process

Prior to the third party undertaking any works/ activities or as part of the planning and design phase, the third party shall ensure a BYDA request is submitted. The automated response received from the BYDA system will be tailored based on the criticality of the assets.



For assets operated at distribution pressures and not considered critical mains, a Duty of Care Notice is provided with the BYDA response for the third party to consider. Site watch may be necessary under a duty of care notice where additional protection or other integrity concerns require it.

In the event that works are conducted within the Protected Zone of a transmission pipeline and/ or critical distribution main, these works will require a review approval received from APA prior to commencement of works. Works subject to this requirement are deemed to include, but not limited to, the following activities that fall under **Table 3**;

- Non Destructive Digging (**NDD**);
- Mechanical excavation including trenchless excavation i.e. drilling (boring, horizontal direction drilling (**HDD**), pipeline bursting and tunnelling) for installing infrastructure such as the following;
 - o Roadways, driveways, railways, pavements;
 - o Electrical equipment (cables, overhead transmission lines, telecommunication cable or power poles);
 - o Installation of culverts/ pipes (water, drainage, sewer or reticulation);
 - o Landscaping.

APA will not approve certain activities and structures in the transmission pipeline easement (if applicable), including the following;

- Permanent storage;
- Installation of billboard structures;
- Use and storage for explosives, flammables or corrosives;
- Blasting;
- Structures forming part of any house, house extensions, carports or entertainment areas;
- Dams and other manmade water features. Locations of dams off the pipeline easement/ protected zone must not create run off or drainage towards the pipeline easement;
- Chemically treated effluent coming in contact with the pipeline easement/ protected zone;
- Garbage, sand fill, refuse disposal;
- Airstrips.

The Third Party must submit an enquiry to APA at the earliest possible stage to allow sufficient time for assessment. Submissions should include the following information;

- Land description and map identifying location of the proposed works;
- Types of works to be carried out;
- Intended future use of the land (where relating to change in land use)
- Type and weight of machinery that will be used;
- Any plans or diagrams of the works;
- Timeframe for the works.

The sequence of obtaining APA approval is as follows;

- a) Submit enquiry for Initial Review – The Third Party submits the request prior to works commencing and APA Networks will complete an 'Initial Review'. The third party must not progress any works on site until they receive a response from APA Networks. The two possible outcomes of this stage are a 'No Impact' response or;
- b) Enquiry Escalated for Standard Assessment – The request will be forwarded to APA Networks Field or System Operations personnel for a more detailed appraisal, which may involve contacting the third party, site visits, locating of assets of site, and/or request for additional information. The third party must not progress any work on site until they receive a response from APA Networks. The two possible outcomes of this stage are a 'No Objection under standard conditions' response or;
- c) Enquiry Escalated for Engineering Assessment – The request has been forwarded to the Integrity Third Party Engagement team for additional appraisal and determination of specific conditions. The third party must not progress any works on site until they receive a response from APA Networks. The two possible outcomes of this stage are a 'No Objection under special conditions response' or;



- d) Enquiry Escalated for Alteration – The Integrity Third Party Engagement team triggers the alteration process for this enquiry. The third party will be contacted for additional information and must not progress any work on site until they receive a response from APA Networks.
- e) No Impact – The third party receives a ‘No Impact’ response and can proceed with the works under appropriate APA Networks requirements e.g. Duty of Care, Authority to Work Permit and/or Site Watch.
- f) No Objection Under Conditions – The third party will receive a No Objection under standard or special conditions response and can progress with the planning of the works under the conditions specified in the response and appropriate APA Networks requirements e.g. Duty of Care, Authority to Work Permit and/or Site Watch.

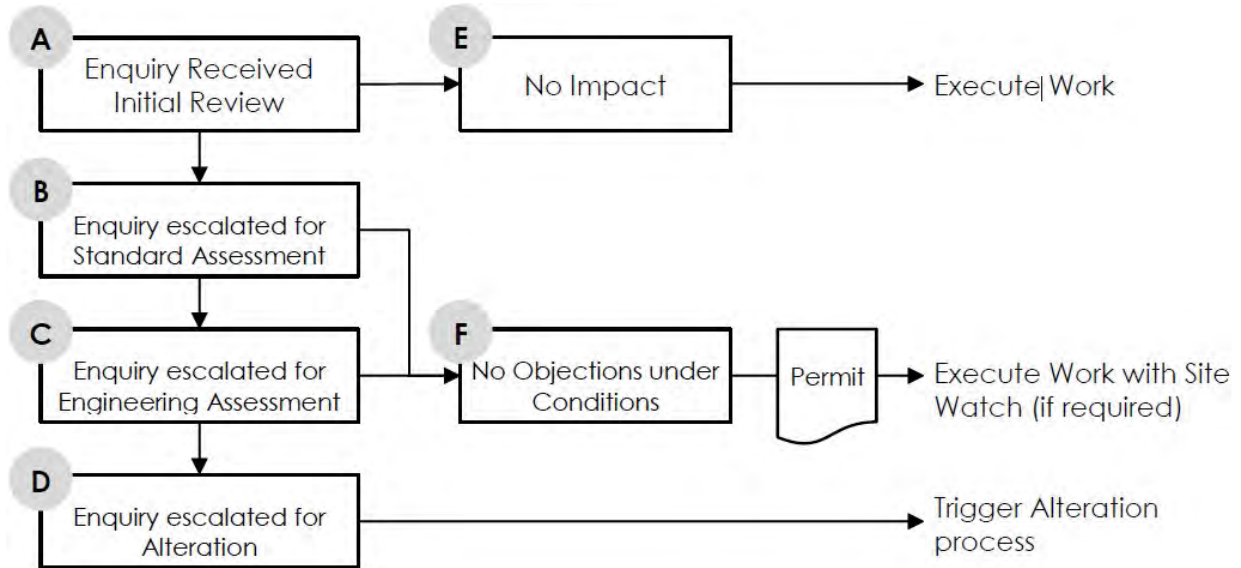

Figure 2 Stages for Third Party Works Authorisation Request

For works around APA Networks transmission pipelines or critical mains the documents take precedence in the following order;

- APA Authority to Work Permit (**ATWP**)
- APA accepted Third Party Construction Drawings
- APA accepted Third Party Construction Methodology
- APA Networks Guidelines for Works Near Existing Gas Assets (this document)
- APA accepted Third Party Safe Work Method Statement (**SWMS**) (if applicable)

3.4 Commercial Agreement and Service Delivery

APA will undertake a review of Third Party Works, as required. At APA’s discretion cost recovery for these works may be required. Where APA Networks requires cost recovery a commercial service agreement in the form of a Works Agreement will be required.

Note: Any third party works requiring blasting, seismic and/or tunnelling work near APA Networks operated assets will not be considered “low risk” and cost recovery for detailed review maybe required.

3.5 Decommissioned Gas Assets

Decommissioned gas assets that remain in the ground are not always shown on BYDA plans.

Where unknown assets are identified or suspected on site but are not on APA plans, they must be treated as being live. In this instance, the third party must contact all utility owners and operators in the area of the BYDA and notify them of the findings.

Following review, if APA accepts that it is a decommissioned gas asset, the asset must be treated as per the requirements of this document. APA will take no further action where it is not considered to be a decommissioned gas asset.

Guidelines for Works Near Existing Gas Assets
400-STD-AM-0001 Revision 2



In some cases, decommissioned gas assets are required for future use by APA (sometimes noted as “Idle” on APA plans). These assets must be treated as live using the same criteria outlined in this document, and must not be removed or altered without APA’s express written approval.

Where APA confirms there is no future use of a decommissioned gas asset (sometimes noted as “Abandoned” on APA plans), removal of the asset can be undertaken by the third party under the following conditions:

- For assets considered by APA to be decommissioned gas assets, APA must be engaged to verify that the asset is gas free;
- End caps must be permanently sealed, using an APA approved methodology, on any decommissioned sections that are to be left in place to prevent future water ingress into the remaining sections of the decommissioned gas asset;
- An as-built drawing must be submitted by the third party for any section(s) of a decommissioned gas asset removed by the third party or its sub-contractors to ensure BYDA can be updated accordingly; and
- Payment for costs associated with any verification or alteration activities must be provided prior to APA undertaking works.



4 PART 2 - DESIGN AND ASSET PROTECTION REQUIREMENTS

4.1 Standard Clearances

Minimum clearance dimensions outlined in this section must be met to allow for safe future maintainability and protection of existing gas assets. If separation clearances cannot be achieved, APA will review the proposed infrastructure on a case-by-case basis to determine whether a resolution can be achieved before alteration of any existing gas assets is considered. Authorisation of works by APA is still required, regardless of being able to achieve the required separation distances.

Clearances specified in **Table 2** are measured from the closest edges of the existing gas asset to the proposed infrastructure. Depending on the exact nature of proposed infrastructure, additional clearance may be required.

Note: Clearances specified herein are from gas assets, third party utilities may have their own standard separations that exceed APA’s minimums specified in **Table 2**.

The future access zone required around a gas asset depends upon a number of factors such as size, operating pressure, depth and soil conditions, but typically this access zone is at least 1000 mm either side and 700 mm below the gas asset. As an aid for design and / or installation, the minimum clearances presented in **Table 2** are provided to allow for safe future access to gas assets. These minimum clearances assume that the asset have been proven and the location verified. There may be circumstances where additional clearances are required.

Table 2 Minimum Clearances

Clearance Type (Note 2, 9)	Minimum Transmission Pressure Asset Clearance	Minimum Distribution Pressure Asset Clearance
Any installation up to 0.6 metres wide which is crossing the gas asset	500 mm Vertical (Note 2)	300 mm Vertical (Note 2)
Any installation over 0.6 metres wide which is crossing the gas asset	500 mm Vertical	300 mm Vertical (Note 2)
Any installation laid by trenchless excavation e.g. HDD, boring, etc.	3000 mm Vertical	600 mm Vertical
	Refer to Section 5.6 for minimum horizontal separation distances	
Any installation laid parallel to a steel gas asset	600 mm Horizontal (Note 2, 3)	
Any installation laid parallel to any gas asset other than steel	N/A	300 mm Horizontal (Note 2, 3)
Trenching separation from edge of gas asset to edge of trench (Note 4)	500 mm Horizontal	300 mm Horizontal
Underground electrical cables laid parallel to any gas asset other than steel	N/A	300 mm Horizontal
Electrical conduits and cables (<11 kV) laid parallel to a steel gas asset	Engineering assessment required (Note 2, 3)	
Electrical conduits and cables (≥ 11kV) laid parallel to a steel gas asset	(Note 2, 3) Engineering assessment required (Note 7)	



Electrical earthing systems near a steel gas asset	High Voltage: Engineering Assessment Required Low Voltage: 300 mm Horizontal (Note 7)	
Electrical earthing system near any gas asset other than steel	N/A	300 mm Horizontal
Clearance Type (Note 2, 9)	Minimum Transmission Pressure Asset Clearance	Minimum Distribution Pressure Asset Clearance
Undisturbed cover from the top of the gas asset to the underside of trenching or road pavement boxing	500 mm Vertical	300 mm Vertical (Note 1)
Distance from predominant building line	3000 mm Horizontal Where applicable outside pipeline easement	Refer to Section 4.2
Distance from Sensitive Use Locations (Refer Section 7 for Glossary of Terms and Abbreviations)	APA Engineering Assessment Required (Note 8)	N/A
Canopies longer than 15 m parallel to the edge of the gas asset	3000 mm Horizontal (Note 10)	Refer to Table 4 (Note 10)
Any installation that could add excessive loads to the gas asset or restrict access to the gas asset	3000 mm Horizontal (Note 2)	
Any installations that may need require underpinning were APA to expose the gas asset	3000 mm Horizontal	
Any temporary stake, e.g. star picket	300 mm Horizontal	
Electrical poles including street lighting and traffic signals	3000 mm Horizontal Where applicable outside pipeline easement	1000 mm (Note 3, 5, 6, 7)
Fence post, including road safety barriers	3000 mm Horizontal when installed per APA requirements	500 mm Horizontal when installed per APA requirements
Pile or pier	3000 mm Horizontal when installed per APA requirements	500 mm Horizontal when installed per APA requirements
Permanent Heavy Vehicle Loads (Greater than 4.5T)	Refer to Section 4.7 Temporary and Permanent Vehicle Loads	
Tree Root Barrier	3000 mm Horizontal	1000 mm Horizontal Refer to Section 4.3 Landscaping Plans
Separation distances for vegetation	Refer to Section 4.3 Landscaping Plans	



Note 1: For distribution main crossings, where the vertical separation distance is less than 300 mm physical protective slabbing, e.g. HDPE or concrete, shall be installed where the other utility is crossing beneath the APA pipeline/distribution main.

HDPE or concrete, shall be installed where the other utility is crossing above the APA pipeline/distribution main.

No protective slabbing is required for utility crossings greater than 500 mm separation.

Note 2: Structures and large utilities crossing APA Networks operated assets need to be self-supporting so that future repairs or maintenance of the asset can occur as per **Section 4.2 Third Party Assets and Structures**.

Note 3: Horizontal separation includes utility surface access pits, thrust blocks and/ or footings.

Note 4: Additional horizontal separation may be required depending on the extent of the planned works, local soil conditions and trench stability of the existing gas asset. This is particularly relevant where works occur within the angle of repose of the existing gas asset (e.g. parallel trenching that is deeper than the existing gas asset) and may result in undermining.

Note 5: In accordance with 'AS/NZS 4853 – Electrical hazards on metallic pipelines' without further information and APA engineering assessment, no electrical power poles for 66kV or above are permitted within the following separation distances of steel gas assets;

- If the power line has an Overhead Earth Wire (**OHEW**) – 15 m;
- If power line does not have an OHEW – 100 m;

Note 6: Where electrical poles (including street lighting and traffic signals) are proposed which place the gas asset within the no dig zone specified by the electrical authority either of the following shall occur;

- a) The poles shall be designed with deeper foundations to be self-supporting if the gas asset needs to be excavated. Or;
- b) For non-metallic assets relocated into a conduit that extends past the no dig zone.

Note 7: Clearance for electrical cables and earthing systems from steel gas assets must be reviewed in accordance with **Section 4.6 Earthing and Electrical Effects**. Electrical cables, substations and/or earthing systems installed in the vicinity of steel gas assets require an Earth Potential Risk (**EPR**) and Low Frequency Induction (**LFI**) assessment to AS/NZS 4853.

Note 8: Requires a setback distance to stay away from the Measurement Length (refer to **Table 14 Glossary of Terms and Abbreviations**). Alternatively, the setback distance may be reduced if protection slabbing is installed along the Sensitive Use Location where interaction with the Measurement Length occurs. This may also be limited to the development area subject to APA engineering assessment.

Note 9: Pipeline protection needs to be assessed and shown on the design plans with design clearances. This includes recoating, bridge slab or asset strike protection slab.

Note 10: Clearance may be dependent on demonstrating that there is sufficient continuous ventilation.



For construction and land use activities around gas assets the minimum horizontal clearances referenced in **Table 3** must be followed.

Table 3 Minimum Clearances for Construction Works and Land Use Activities

Construction and Land Use Activities	Minimum Horizontal Clearance	
	Transmission Pressure & Critical Distribution Mains	Non-Critical Distribution Pressure Mains
Excavation without APA representative present (Note 1)	3000 mm	N/A
Trenchless Excavation (Note 1)	3000 mm Refer to Section 5.6	1000 mm Refer to Section 5.6
Temporary Heavy Vehicle Traffic (greater than 4.5T)	If the load has not been assessed, maintain a Horizontal separation of 3000 mm. APA engineering assessment must be completed if crossing asset. Refer to Section 4.7 Temporary and Permanent Vehicle Crossings	Refer to Section 4.7 Temporary and Permanent Vehicle Crossings
Installation of Piles, Piers or Poles	Refer to Table 2 and Section 5.7	
Hot Works from Construction Activities	Any hot works within 5000 mm of an open trench containing gas asset or where cover is less than 300 mm. Refer to Section 5.8. (Note 2)	
Compaction	Section 5.10 for Compaction Limits Maximum Compaction Limits	
Vibration Limits	No vibration within 3000 mm of the pipeline and greater distance to comply with Section 5.9	
Blasting, Seismic Survey or the use of Explosives	Approval required for works within 100m. Refer to Section 5.11 .	
Lifting over exposed gas asset	Not permitted over the gas asset. Refer to Section 5.12 for Suspended Materials above Gas Assets and No Go Zones for Cranes.	
Clearance of crane outriggers to gas assets	Not permitted within 3000 mm of gas asset. Refer to Section 5.12 for Suspended Materials above Gas Assets and No Go Zones for Cranes.	
Clearance of temporary material from pipeline	Not permitted within 3000 mm of gas assets. Refer to Section 5.13 for Temporary Materials.	

Note 1: Excavation covers NDD, mechanical excavation and trenchless excavation (boring, HDD, pipeline bursting and tunnelling).

Note 2: Horizontal separation distance also applies to any pits or valve covers.



4.2 Third Party Assets and Structures

Structures, including but not limited to buildings, walls, canopies, footings, pile caps or retaining walls, must not transfer any load to or be installed over any gas asset.

The design of any third party asset or structure must take into account future safe access of any gas assets in the vicinity. The proposed third party asset or structure must be installed in a way that prevents the angle of repose from encroaching into the future access zone as specified in **Section 4.1** around the existing gas asset.

Any third party asset or structure installed within proximity to a transmission pipeline or critical distribution pressure main must be designed to be self-supporting and allow for a minimum excavation window 1m on either side of the asset and 700 mm below the edge of the asset, for maintenance of the asset. This self-supporting design information is required to be shown on the construction drawings supported by geotechnical data and calculations. Construction of structures on pipeline easements are not permitted without explicit consent from APA.

Distribution pressure gas mains must be offset from the expected predominant building line at a distance in accordance with **Table 4**. Transmission pressure gas assets shall be per **Table 2**.

Table 4 Minimum Building Offset Distances for Distribution Pressure Gas Mains

Diameter (DN)	MAOP (kPag)			
	≤210	>210 ≤ 420	>420 ≤ 600	>600
≤110	0.5 m	0.5 m	1.0m	3 m
>110 ≤ 160	0.5 m	0.5 m	3 m	5 m
>160	0.5 m	3 m	3 m	8 m

Gas assets may be located underneath curbing or strip footings for road safety barriers for short sections up to 10 m to allow for tapers. The integrity of the gas asset to be located underneath the curbing or strip footing may require inspection, repair, recoating and / or slabbing depending on the existing condition and extent of proposed works.

Posts or poles which are located in road reserve, or otherwise exposed to vehicle impact, must be designed such that there will be no damage to the gas asset in the event of a vehicle impact.

For works in Victoria, consent from the relevant State Minister is required under Section 120 of the *Pipelines Act 2005* (VIC) for the erection of structures or buildings within 3,000 mm of a transmission pressure asset. Ministerial consent must be arranged through Energy Safe Victoria (**ESV**) following review and acceptance of the proposed designs by APA Networks.

4.3 Landscaping Plans

Vegetation may limit line of site, access and passage along an existing gas asset alignment, while the associated roots may damage existing buried pipe, coating or other ancillary equipment (e.g. cables). Above ground gas infrastructure may also be exposed to hazards from falling vegetation and increased fire risk. Additionally, trees and tree roots may limit access to the gas asset in an emergency, during normal operations and when make new connections or modifications.

Landscaping plans which include vegetation should select tree species which do not have vigorous root activity and do not exceed above 5m in height when fully mature when planted within 3m of gas assets. The pre-selection of trees considered suitable for planting within road reserves and near gas assets should also consider interference with, or damage to, other underground and overhead services.

For all landscaping works within 3 m of transmission pressure or critical distribution pressure gas assets the following details must submitted to APA for review and approval prior to planting.

- Tree species – botanical and common name
- Mature tree buttress and canopy diameter
- Mature tree height



- Maximum root ball diameter
- Offset from gas asset
- Method of protection to gas asset

Trees to be planted within 3 m of transmission pressure or critical distribution pressure gas assets, should also adhere to **Table 5** below.

Note: Horizontal separation is measured from pipe edge to edge of mature trunk or mature drip line, whichever is the greater.

Strata cells are not considered an appropriate protection from tree roots. If strata cells are to be installed in the vicinity of existing buried gas assets, the controls identified in **Table 5** must be used for protection.

Table 5 Protection of Distribution Gas Assets from Vegetation

Vegetation Types	Requirements	Horizontal Separation from Pipe Edge to Vegetation			
		Greater than 3 m	1.5 to 3m	1.5 to 0.5 m	<0.5 m
Trees or Large Shrubs	Min. separation of 3 m is required between trees and pipe if no protection methods are utilised.				
Medium and Small Shrubs	Within 1.5 m – 0.5 m protection methods must be utilised.				
Ground cover and grasses	No protection methods required.				
Gas Protection Methods					
	No protection methods required, provided separation limits are followed.				
	Within 3 m, tree species which have mature buttress diameters less than 0.15 m and do not have invasive or deep roots may be accommodated without protection methods after consultation with APA Networks (Note 1). For trees with mature buttress diameters greater than 0.15 m one of the following gas protection methods must be implemented; <ol style="list-style-type: none"> 1. Lowering or relocation of the gas asset to a minimum of 1.2 m cover. 2. Installation of new gas conduit beyond the structural root zone (SRZ) of the mature tree species for future use. (Note 2) 3. Installation of a root barrier system. System to be 1 m deep or extend 250mm below the gas asset, whichever is the greater. 				
	Within 1.5 m installation of a root barriers system is mandatory and gas protection methods are as follows; <ol style="list-style-type: none"> 1. Installation of a robust root barrier system. System to be 1 m deep or extend 250 mm below the gas asset, whichever is the greater. AND <ol style="list-style-type: none"> 2. Lowering or relocation of the gas asset to a minimum of 1.2 m cover. OR <ol style="list-style-type: none"> 3. Installation of new gas conduit beyond the SRZ of the mature tree species for future use. (Note 2) 				
	Planting directly over gas assets is not permitted in any location, as it prevents emergency and maintenance access. Tree roots can damage gas asset resulting in gas leaks.				



Note 1: Refers to the minimum 1.5 m structural root zone for a mature buttress diameter less than 0.15 m mandated under AS 4970 – Protection of trees on development sites.

Note 2: Suitable protection method for PE mains only. Conduits to be recorded in Geographic Information System (GIS) for future referencing.

Note 3: On transmission pressure assets vegetation must not limit line of site along the buried gas assets alignment, all signage must remain each in sight of the other.

4.4 Surface Levels and Conditions

Decreases or increases to surface levels must consider depth of cover requirements for gas assets specified in **Table 6**. This is in addition to maintaining a minimum working cover from the top of the gas asset to the underside of trenching or road box out works during construction as specified in **Table 2**. Vehicles must not cross gas assets at covers less than those specified in **Table 6** unless in accordance with **Section 5.10** for Compaction Limits or **Section 4.7** for Temporary and Permanent Vehicle Crossings.

Where existing surfaces are to be modified, finished cover levels are not to be reduced to less than existing levels, unless meeting the minimum requirements of **Table 6**. The requirement for, and the extent of, protective slabbing over any APA Networks operated asset will be determined by APA at its sole discretion with adherence to minimum depth of cover without physical protection as the preference. Depending on the location, local councils and relevant road/ rail authorities may have minimum depth of cover requirements that APA are required to meet which are more stringent than those listed in **Table 6**. Depth of cover requirements for individual consumer offtakes (service connections) are also provided in **Table 7**.

Details of any additional fill proposed to be placed on or within 3 metres of a gas asset, or within any applicable easement, must be clearly shown on plans and must be approved by APA Networks in writing. A maximum depth of cover of 2,500 mm for transmission pressure assets and 2000 mm for distribution assets apply in all locations; however, it is preferred not to exceed 1500 mm for both types of assets.

Table 6 Minimum Depth of Cover Requirements for Pipelines and Mains

Asset Location	Minimum Depth of Cover (Note 3)	
	Transmission Pressure Asset	Distribution Pressure Asset
Under Minor Road Pavement (Note 1)	<ul style="list-style-type: none"> • 1,200 mm • 1,200 mm to 1,000 mm with physical protection slabbing and APA engineering load assessment 	<ul style="list-style-type: none"> • 750 mm • 750 mm to 600 mm with physical protection slabbing and APA engineering load assessment
Under Major Road Pavement (Note 2)	<ul style="list-style-type: none"> • 1,200 mm • 1200 mm to 1,000 mm with bridging slabs (Note 4) 	<ul style="list-style-type: none"> • 1,200 mm • 1200 mm to 750 mm with bridging slabs (Note 4)
In Road Reserve but not Under Road Pavement	<ul style="list-style-type: none"> • 900 mm • 900 mm to 750 mm with protective slabbing contingent upon pipeline location class 	<ul style="list-style-type: none"> • 750 mm • 750 mm to 600 mm with protective slabbing
Not in Road Reserve	<ul style="list-style-type: none"> • 900 mm • 750 mm with protective slabbing contingent upon pipeline location class 	<ul style="list-style-type: none"> • 750 mm for > 210 kPa • 600 mm for ≤ 210 kPa
Railway Reserve	2000 mm (Note 5)	
Large Open Drain or Major Water Crossing	2000 mm (Note 6)	



Note 1: Minor road pavements typically are owned by local councils.

Note 2: All roads owned by state and federal authorities are major roads. Roads owned by council may be major or minor roads. Covers less than 1200 mm may require dispensation from the relevant road authority.

Note 3: Protective slabbing must be installed where minimum depth of cover requirements cannot be met or are required to meet specific safety requirements. Bridging slabbing for transmission pressure assets may be replaced with protection slabbing following APA engineering assessment.

Note 4: The requirement for bridging slabs can be downgrade to physical protection slabbing where APA engineering assessment is completed and approved.

Note 5: Installation within railway reserve shall be in accordance with both AS 4799 and the respective operating standard for the gas assets i.e. AS 2885 and AS 4645.

Note 6: The minimum depth of cover of 2,000 mm shall consider future scour of the drain or waterway crossing. For man-made drains the depth of cover can be reduced to 1200 mm if sealed (i.e. concreted) and appropriately designed. For transmission pressure assets, waterway crossings shall be designed in accordance with AS 2885.1 – 2018 Clause 5.8.6.2. For all assets, as a minimum the following shall be considered;

- a) A hydrological investigation to determine the stream power under peak stream, watercourse or waterway flows. The investigation shall determine the 1 in 100 year flood and the probable maximum flood and intermediate (optional) flood conditions.
- b) A geotechnical investigation to determine the physical parameters of the crossings, and using the information from the hydrological investigation, the erosion potential. This assessment should also consider the meander potential of the watercourse so that the limits of special construction can be defined.

Table 7 Minimum Depth of Cover Requirements for Customer Offtakes (Services)

Asset Location	Customer Offtake size	
	≤ DN50	> DN50 and ≤ DN110 (Note 1)
Roadway	450 mm	600 mm
Private Property	300 mm	450 mm

Note 1: Customer offtakes (services) with diameters greater than DN110 shall have depth of cover in accordance with **Table 6**.

Changes to surface conditions (e.g. changing from nature strip to road pavement) or which place the gas asset in an inaccessible position (e.g. with excessive cover) may require slabbing, recoating and / or relocation. Changes to surrounding surface levels or conditions must also consider drainage and the potential to result in erosion of cover for gas assets. Additionally, gas fittings such as valves, stopple fittings or flanges must not be located underneath road pavement. An APA Engineering assessment will be required if this is not feasible, refer to **Section 6**.

Where a new hardstand surface is installed on non-metallic distribution pressure mains (e.g. a painted concrete driveway), consideration should be given to including a casing or enveloper pipe to APA requirements for insertion of future gas assets. This will ensure that the new hardstand surface is not modified as part of the future gas installation. Where a casing or enveloper pipe is installed for future insertion works surveyed as-constructed records are to be provided to APA Networks for incorporation into the GIS records.

For transmission pressure gas assets, any landscaping material should be level within the easement or a minimum of 3 m (but preferably 6 m) to each side of the pipeline, to permit excavating equipment to operate without having to destroy the adjacent landscaping.

4.5 Casings Vent Stacks

Casings provide mechanical protection and protection to gas assets from external loadings. Some cased crossings are sealed and fitted with a casing vent stack, which gas leaks are identified via.

The following APA requirements are to be applied for works near casing vent stacks:



- Casing vent stacks cannot be removed unless an alternative arrangement has been approved by APA Networks or they have been assessed as being redundant;
- Unfettered access is to be maintained to casing vent stacks; and
- Minimum distance from casing vent stack discharge point to any electrical installation or overhead structure must be 1000 mm.

4.6 Earthing and Electrical Effects

Steel gas assets are susceptible to adverse effects from electrical sources such as above and below ground cables, substations, transformers, earth rods, cathodic protection systems or electrified tram / train lines.

Without any further information or engineering assessment, earthing systems for distribution ($\geq 11\text{kV}$) and transmission ($\geq 66\text{kV}$) power lines must satisfy the Earth Potential Rise (EPR) Level 1 (Conservative) compliance of AS/NZS 4853 – 2012 Table 4.3 & 4.5 which specifies separation distances from pipe appurtenances (e.g. valves, regulators, isolation joints), access points or earth points (including cathodic protection test points). For the potential hazards to be accepted as low risk on the basis of a Level 1 assessment the separation between a conductive structure or substation and pipeline subject to EPR shall be greater than the values given in **Table 8** below.

Table 8 Separation Distances for Pipeline Subject to EPR from Power Lines (Level 1 Assessment)

Fault Current or Actual Current (A) (Note 2, 3)	Separation Required (m) - Note 1				
	Distribution ($\geq 11\text{kV}$)	Power Line	Transmission ($\geq 66\text{kV}$)	Power Line	
	100 $\Omega\cdot\text{m}$	500 $\Omega\cdot\text{m}$	100 $\Omega\cdot\text{m}$	500 $\Omega\cdot\text{m}$	
150	40	190	N/A	N/A	
300	80	390	N/A	N/A	
500	130	660	N/A	N/A	
750	200	1,000	N/A	N/A	
1,000	270	1,300	60	310	
3,000	N/A	N/A	190	940	
6,000	N/A	N/A	380	1,900	
10,000	N/A	N/A	635	>3,500	

Note 1: Earth resistivity of 500 $\Omega\cdot\text{m}$ shall be used for dry sand or rock and 100 $\Omega\cdot\text{m}$ for all other cases.

Note 2: If the fault current is unknown for a distribution power line ($\geq 11\text{kV}$), a fault current of 1000 A shall be used for the first pass assessment.

Note 3: If the transmission power line ($\geq 66\text{kV}$) uses an OHEW, uses values up to 3,000 A (this assumes a current split of 30% of 10 kA). For lines without an OHEW, use values up to 10,000 A for current going down the structure.



Without any further information or engineering assessment, distribution (≥ 11 kV) and transmission (≥ 66 kV) power lines parallel to steel gas assets must satisfy the Low Frequency Induction (LFI) Level 1 (Conservative) compliance of AS/NZS 4853 – 2012 Table 4.2 & 4.4 which specifies maximum acceptable power line to pipeline exposure length.

Per AS/NZS 4853 – 2012 the pipeline expose length (average separation for the parallel section) under LFI conditions shall be less than the values given in **Table 9** below.

Table 9 Exposure Length for Pipeline Subject to LFI from Power Lines (Level 1 Assessment)

Power line to pipeline separation (m)	Exposure Length (m) – Note 1	
	Distribution Power Line (≥ 11 kV) – 100 Ω .m	Transmission Power Line (≥ 66 kV) – 100 Ω .m
5	180	95
10	210	110
20	240	127
50	310	165
100	400	210
200	550	290
500	950	500

Note 1: Without soil resistivity data, assessments are to be completed assuming 100 Ω .m. If soil resistivity data is available refer to AS/NZS 4853 – 2012.

Where AS/NZS 4853 Level 1 EPR or LFI requirements cannot be achieved a Level 2 and/or 3 assessment will be required.

The third party must provide to APA detailed plans of any source(s) of earthing and/ or electrical effects proposed to be located in the vicinity of steel gas assets, with an assessment report compliant with AS/NZS 4853 Electrical Hazards on Metallic Pipelines. This assessment report is to determine any effects to existing cathodic protection or induced voltage mitigation systems from these types of installations. The third party must address any relevant requirements and any recommendations and/or actions must be implemented to the satisfaction of APA Networks. All cost association with the study, and implementing its recommendations and/ or actions are to be borne by the third party. The third party must also complete validation testing upon completion of construction and provide all findings/ reports to APA Networks.

Hazards which may arise due to electrical systems located in the vicinity of steel gas assets include the following:

- Accidental contact between gas assets and electrical systems;
- Capacitive coupling;
- Conductive coupling;
- Electromagnetic induction;
- Low Frequency Induction (LFI);
- Earth Potential Rise (EPR), including due to fault current or lightning discharge; and,
- Adverse cathodic protection interference in excess of those allowed under AS 2832.1 or relevant state regulations

4.7 Temporary and Permanent Vehicle Crossings

Vehicle crossings over existing gas assets are limited to light vehicles (Gross Vehicle Mass not greater than 4.5 tonnes unless advised otherwise by APA Networks in writing) on unsealed surfaces or Heavy Vehicles (compliant General Access Vehicles) on established road pavements.

Any proposed new crossings must be assessed and authorised in writing by APA Networks.



A maximum surface pressure of 400 kPa is allowable directly above buried gas assets. However, any surface pressure exceeding this limit or where cover over the gas asset has been reduced from **Table 6** will require an APA Engineering Assessment and approval.

Where soil conditions exhibit poor compaction and load bearing characteristics, such as wet soil conditions, equipment is not permitted to cross the gas asset irrespective of weight without establishing a stable sealed surface or road plates.

Crane footings or bog mats must not be placed where the angle of repose can influence an existing gas asset without express written approval by APA. Where the existing gas asset is within the angle of response, the maximum surface pressure due to the crane must be provided.

5 PART 3 - CONSTRUCTION AND LAND USE REQUIREMENTS

Extreme care should be exercised at all times when working around existing gas assets, as repair works will be fully chargeable and may result in delays to any works. Refer to the duty of care outlined in **Section 1.4** and the requirements of this section when selecting construction methods.

5.1 Land Use Change

Where works proposed by a third party may result in a change in land use within the Measurement Length (as defined in AS/NZS 2885.6 for Pipelines – Gas and Liquid Petroleum) of transmission assets, such works may also be subject to formal approval requirements through APA Networks and applicable local and state government planning processes.

This may also require a Safety Management Study (SMS) report be completed and approved by APA Networks. This SMS report is generated from an SMS workshop involving an independent SMS facilitator, third party and APA Networks. APA Networks is the owner of the SMS report and any resulting recommendation/ actions must be implemented to the satisfaction of APA Networks prior to the commencement of any physical works.

Certain categories of development, such as Sensitive Use Locations (refer to **Table 14 Glossary of Terms and Abbreviations**), are not appropriate to be located with the Measurement Length. In certain circumstances, the otherwise unacceptable risks associated with such developments may be alleviated with the aid of installing protective slabbing over the transmission pipeline or undertaking other protection and mitigation measures.

Sensitive Use Locations near transmission pipelines are designated under AS/NZS 2885.6 and identify land where the consequences of a Failure Event may be increased because it is developed for use by sectors of the community who may be unable to protect themselves from the consequences of a pipeline Failure Event.

Sensitive uses are defined as follows;

- Schools, which includes colleges
- Hospitals and aged care facilities such as nursing homes, elderly people's homes
- Prisons and jails
- Sheltered housing
- Buildings with five or more stories
- Large community and leisure facilities, large open air gatherings
- Day care facilities
- Other potentially difficult to evacuate facilities
- Other structures as defined by relevant local councils.

For further information regarding the SMS process, refer to APA Networks Encroachment and Land Use Change SMS Trigger Procedure, **400-PR-L-0003**.

5.2 Permits and Site Watch

Transmission pressure assets and critical distribution pressure assets, must have a permit issued prior to proposed works in the vicinity of the existing assets, including any proving activities. Following the issue of a permit, a site watch inspector may be required to verify that the activities are carried out appropriately.



Other distribution pressure assets not considered critical will only require site watch as determined by APA Networks.

Where a permit is required, the response provided to the BYDA enquiry will include the relevant forms and process to be followed for submitting a permit request.

While BYDA recommends completing the request two business days prior to undertaking works, this is to ensure that the location information is obtained. This may not allow sufficient time for APA Networks to supply site watch. Further delays may be experienced if the proposed works are significantly complicated, do not meet the requirements of this document or if insufficient information is provided.

It is an offence in all jurisdictions to undertake activities in the vicinity of transmission pipelines without prior authorisation by the operator.

5.3 Coating Surveys and Leakage Surveys

Where proposed works have potential to indirectly damage pipe coating (i.e. due to compaction) or result in a leak of the gas asset (e.g. vibration of cast iron pipes), additional monitoring activities such as Direct Current Voltage Gradient (DCVG) or leakage surveys may be required.

If required, chargeable DCVG surveys will be conducted prior to works to establish any existing coating faults which exist on the gas asset. A subsequent DCVG survey will be conducted at the conclusion of works, and where new faults have developed on the gas asset, repairs shall be made with costs charged to the works owner. Surveys can be conducted prior to finalising road surfaces to avoid costly repairs.

A similar chargeable survey program can be applied where leakage surveys are required. However, additional surveys may be necessary throughout works to ensure work crews do not operate in a gaseous environment once leaks are caused.

5.4 Pipeline Repairs, Recoating and Slabbing

Buried steel assets operated by APA Networks are coated to provide protection from corrosion.

Where the surface conditions above a buried steel pipe are changed which may limit future access to the existing gas asset an assessment of the coating condition will likely be triggered.

The requirement for pipeline recoating is assessed by APA Networks on a case by case basis, based on the proposed works, but will generally be dependent on the following:

- The asset class;
- The existing coating type, age and condition;
- Increase in loading that can bring forward any pipeline anomalies; and,
- Changes limiting access to the existing asset(s), such as the installation of slabbing, road pavement, culverts, embankment ramps or any other feature.

A chargeable coating survey carried out in accordance with **Section 5.3** may be required to assess the condition of the existing gas asset coating.

Recoating and/ or associated slabbing works over any gas asset will be determined by APA Networks Engineering Assessments and any applicable risk assessments (Safety Management Study or Formal Safety Assessment).

Pipeline repairs, recoating and slabbing that form part of any third party commercial agreement will be charged to the third party.

The requirement for, and the extent of, slabbing over any APA Networks operated asset will be determined by APA at its sole discretion and may depend on factors other than only changes in depth of cover discussed in **Section 4.4**. Slabbing may be required for the following reasons:

- Removable protective slab to provide protection from third party mechanical excavation;
- Bridging slab to provide protection from external loadings e.g. insufficient depth of cover combined with vehicle traffic.

Slabbing must be installed with adequate separation from the pipe, which may impact the undisturbed cover requirement, and cannot be installed directly underneath road pavement or at surface level.



Any bridging slab designs prepared by a third party must be accompanied by certification from the registered practising structural engineer (Registered Professional Engineer Queensland (**RPEQ**) required for works in Queensland, and so on as required for other States and Territories) confirming that the design is adequate to prevent pipeline loading.

5.5 Exposure of Buried Gas Assets

5.5.1 General

Excavation works covers Non-Destructive Digging (**NDD**) and mechanical excavation. All such excavations must be completed in accordance with APA's direction.

The Third Party or its Contractor can perform exposure works on APA Networks operated assets via NDD using vacuum excavation and subsequent mechanical excavation works under the following conditions:

- **A current BYDA request is available for the works.**
- An approved Authority to Work Permit (**ATWP**) is issued for works near transmission pipelines or critical mains.
- APA Site Watch Officer is present for works near transmission pipelines or critical mains as outlined on the ATWP.
- The Third Party (or its Contractor) shall ensure they have their own SWMS, Risk Assessment, Environmental Management Plan, Tool Box Talk, Traffic Management and Pre-Start in line with their own corporate policy in place prior to works commencing.
- All underground assets have been identified by surface marking where within or close to the excavation area prior to proceeding with planned proving works (i.e. hand or NDD (e.g. Hydro-Vacuum Excavation). Any non-recorded assets should be identified prior to breaking ground (e.g. excavation or cutting).
- A check for gas leaks has been conducted prior to the commencement of work.
- If the mechanical excavation operator cannot see the spotter (where applicable, APA Site Watch Officer), he or she must stop moving immediately and not resume movement until contact has been established. Spotters must be aware of their surroundings and should never walk into the path of a vehicle, moving equipment or a swinging load. They need to scan the ground to become aware of any trip or fall hazards.
- If excavations are greater than 1.5 m or ground conditions are considered unstable benching/ battering/ shoring must be utilised. Additionally, appropriate ladders/ ramps or steps must be utilised to ensure safe access and egress.
- **Under no circumstances is mechanical equipment to be used within 300 mm of any gas asset.**

5.5.2 Physically Proving Gas Assets

Prior to mechanical excavation of the gas assets, the asset shall be physically proven by NDD or through the use of hand excavation. The method used will vary based on the criticality of the asset. The requirements in **Section 5.5.1** shall be implemented prior to physically proving the gas asset.

Technique 1 – Vacuum Excavation (Critical and Non-Critical Gas Assets)

A vacuum truck can be used to prove and expose the gas asset. Please ensure the requirements detailed in **Section 5.5.3** are adhered to.

Technique 2 – Hand Excavation (Critical and Non-Critical Gas Assets)

If the anticipated depth of cover of the gas asset is less than 1m (measured from the top of pipe) then hand excavation shall be used to expose the gas asset. The use of round edge shovels should be used to avoid damage to the pipe or coating. In the event that the anticipated depth of cover of the gas asset is greater than 1m then mechanical excavation can be undertaken in accordance with the requirements of **Section 5.5.4** but must stop when within 1m of the gas asset (i.e. 1.3m anticipated depth means that 300 mm of cover can be removed by mechanical excavation and the



remainder by hand excavation as described above. The anticipated depth shall be based on the shallowest result from BYDA or pipe locator.

Technique 3 – Hand + Excavation (Non-Critical Gas Assets ONLY)

If the gas asset is deemed non-critical then a combination of hand digging and excavation can be used. This technique requires the third party to hand excavate 300 mm then mechanically excavate the first 150 mm. In this technique the hand excavation shall always lead the mechanical excavation by 150 mm. Once within 300 mm of the gas asset then only hand excavation is allowed.

5.5.3 Hydro-Vacuum Excavation

Where hydro-vacuum excavation is used in the vicinity or to expose existing gas assets, the following conditions must be applied:

- Ensure the general requirements in **Section 5.5.1** are adhered to prior to the works commencing.
- Root cutting heads shall not be used at any time.
- When locating pipelines and mains, a maximum water pressure of 2500 PSI (17200 kPa) may be used to a depth no greater than 450 mm. Below this depth, the maximum water pressure shall be set in accordance with **Table 10** for the asset type in the vicinity.
- When locating customer offtakes (services), a maximum water pressure of 2500 PSI (17200 kPa) may be used to a depth no greater than 300 mm. Below this depth, the maximum water pressure shall be set in accordance with **Table 10** for the asset type in the vicinity.
- Where air is used in place of water the air pressure shall not exceed 175 PSI (1200 kPa).
- A minimum distance of 200 mm shall be maintained between the nozzle tip and subsoil and vertical movements avoided (i.e. nozzle shall not touch or be inserted into soil).
- The wand shall never remain motionless during excavation. Aiming directly at the gas asset shall be avoided at all times.
- NDD vacuum equipment must not come into contact (impact) with the pipe or coating.
- Once a gas asset has been exposed via hydro-vacuum methods, a visual check must be undertaken to ensure no damage has occurred to the pipe or its coating. Damage caused to the pipe coating by the third party will be chargeable.
- A dead man trigger or similar, shall be installed and used on the wand.
- If conduits are to be installed for identification of the gas assets location the conduit shall be offset to one side and recorded or a flexible conduit installed over the gas asset. The placement of PVC pipes directly on the gas asset may cause damage to the pipe coating and require repair at the contractor's expense.
- Vacuum excavated holes shall be cleaned of any rocks and debris and backfilled with a minimum 300 mm of sand.

Personnel operating NDD equipment shall monitor ground conditions to determine and adjust for the lowest water pressure setting and vacuum used to adequately expose the gas asset. The objective shall be to use the lowest possible pressure and vacuum required to adequately excavate in order to minimise risk of coating and/or pipe damage. **Table 10** provides the maximum water pressure to be used for various pipe and coating types.



Table 10 Maximum Water Pressure for Hydro-Vacuum Excavation

Pipe / Coating Type		Max. Water Pressure (PSI)	Pipe / Coating Type	Max. Water Pressure (PSI)
Steel	Coal Tar Enamel Coated	1,000	Steel – Mummified fittings (e.g. valves, flanges)	Not Permitted
	Polyethylene Tape Coated	1,000	Cast Iron	1,000
	Polyethylene Coated	2,000	Polyethylene	2,000
	Trilaminate Coated	2,000	Nylon or PVC	1,500
	FBE or HBE Coated	2,000	Unknown Material or Steel Pipe Coating	1,000
	Uncoated	2,500		

5.5.4 Mechanical Excavation

Prior to commencing any excavation works the general requirements in **Section 5.5.1** must be adhered to.

Where works are to be carried out within 3 m of the gas alignment and to 1 m of the known gas main depth, the contractor is required to pothole and expose the gas asset as outlined in **Section 5.5.5**.

Prior to the mechanical excavation commencing ensure the excavator is in working order and all pre-start equipment checks are completed.

Excavators with general purpose buckets (e.g. mud bucket, general purpose teeth) up to 30 tonnes are permitted to conduct mechanical excavations in the vicinity of existing APA gas assets in accordance with APA requirements. Any variation of excavator size or bucket type will require assessment and approval by APA Networks. Buckets with any type of tiger or penetration teeth are not permitted unless explicitly approved by APA Networks.

Critical Gas Assets

No mechanical equipment shall be used within 1 m of the potholed depth of the critical gas asset, except under explicit on site direction from an APA representative (i.e. APA Site Watch).

Under no circumstances is mechanical equipment to be used within 300 mm of any gas asset.

Once the gas asset has been positively proven, as outlined in **Section 5.5.2**, mechanical excavations can commence at a minimum of 300 mm offset from the outer edge of the pipe. The third party shall not mechanical excavate directly over a critical gas asset, with hand excavation only directly over the alignment or to expose the asset.

Figure 3 Gas Asset Side Excavation Method

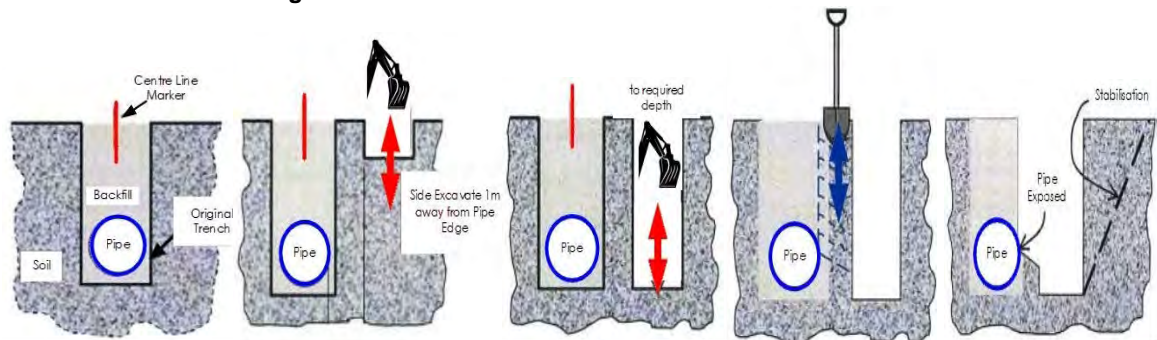



Non-Critical Gas Assets

Mechanical excavation is permitted directly over the top of non-critical gas assets however **under no circumstances is mechanical excavation equipment to be used within 300 mm of any gas asset.** If the third party is in doubt with regards to the criticality of the gas asset, then the excavation method outlined for critical gas assets shall be used.

Prior to the mechanical excavation commencing, the asset shall be physically proved as outlined in **Section 5.5.2**. Once the depth has been physically proven the third party can proceed with excavating around the gas asset until within 300 mm. From this point hand excavation or NDD is required.

5.5.6 Protection During Exposure

Additional protection measures are required where an exposed gas asset may be subject to impact from construction activities, sagging of exposed pipe and trench instability. Any works requiring exposure and protection of the gas asset should have an accompanying methodology and approval by APA Networks.

Physical protection (e.g. structural steel protection, sandbags, wrapped with split PVC pipe) should be installed around the exposed gas asset when exposed, particularly when new infrastructure is planned to be installed crossing below the gas asset. If the gas asset is to be exposed for longer than one day or otherwise left unattended, suitable barricades, security fencing and/ or steel plates will be required to provide protection from vehicles, dropped objects (such as construction materials) or vandalism.

Unsupported exposed pipe lengths require protection from sagging by using suitable supports such as sandbags or slings. Where slings or other support types come into contact with the gas asset, protection methods must be employed (e.g. wrapped with split PVC pipe) to prevent damage to the existing pipe or coating. Exposed unsupported joints must also be identified and supported during works. The maximum allowable length of exposed pipe without support is provided in **Table 11**.

Table 11 Maximum Unsupported Lengths of Exposed Pipe

Gas Asset Diameter (mm)	Steel Maximum Unsupported Length (mm)	Polyethylene Maximum Unsupported Length (mm)	Other Maximum Unsupported Length (mm)	Material
≤20	2,000	1,500	1,500 (Note 1)	
>20 & ≤63	2,800	2,000		
>63 & ≤100	3,600	3,000		
>100 & ≤150	4,200			
>150 & ≤250	5,000			
>250	5,700			

Note 1: Particular care should be taken for other materials include cast iron, PVC or nylon due to the unpredictable nature of the joints.

Additional protection and support during trench or bell-hole excavation works to minimise ground instability may also be necessary to protect the integrity of existing gas assets during exposure works. Trenches are to be inspected prior to commencing works each day and monitored by the onsite party responsible for the excavation. APA shall be notified of any condition likely to affect the stability of trench.

Any deep excavations, within 3 m of a gas asset, shall be designed and constructed such that the effects of subsidence, collapse or extreme weather will not affect the gas asset. Any such excavations prepared by a third party must be accompanied by certification from a registered practising engineer (RPEQ required for works in Queensland, and so on as required for other States and Territories) confirming that the design is adequate to protect the gas asset.



5.5.7 Backfill and Reinstatement

Prior to backfilling, a minimum of 150 mm of bedding sand must be placed around all gas assets. Bedding sand shall be in accordance with APA specification **400-SP-L-0002**, which can be provided to third parties upon request. The bedding must be compacted in accordance with **Section 5.10**, including suitable compaction and backfill of the underside of the gas asset to prevent any further vertical movement during subsequent layers above the asset. APA may require geo-fabric installation between different trench reinstatement products to prevent sand migration in which nonwoven fabric is required and needs to extend 1000 mm past either side of the utility crossing.

The bedding material shall be clean, free from all sharp objects, sandbags, clay material, vegetable matter, building debris and disused road paving material to the specification provided by APA. Recycled bedding material and stabilised sand must not be used unless explicitly approved by APA.

The remainder of the excavation shall be backfilled and compacted in accordance with **Section 5.10**, at maximum increments of 300 mm to a density which is similar to the surrounding sub-grade material. Only clean fill material shall be used, preferably the same as the natural soil in the area, and free from ash, weeds and pest plants, salt or any chemicals which could harm the gas assets. Where required, concrete slabbing shall be installed in accordance with **Section 5.4**.

In all circumstances gas warning tape / marker board shall be installed in accordance with the following requirements:

- Gas warning tape installed at 300 mm below finished surface level.
- Gas marker board installed 300 mm above the top of the pipe.

Note, where gas warning tape cannot be installed 300 mm below the finished surface level due to road pavement box out, marker board is to be installed 50 mm below the box out work zone.

In situations where a physical protection slab or bridging slab has been utilised an additional layer of gas marker board must be installed 50 mm above the slabbing.

The excavated area is to be reinstated to the original condition or as approved by APA and the relevant local council, road authority or landowner as applicable. Any marker signs removed during excavation works must also be reinstated in original positions. Additional marker signs may be required at new infrastructure crossings as directed by APA.

5.6 Trenchless Excavation

Trenchless excavation covers horizontal directional drilling (**HDD**), boring, pipe bursting and tunnelling. These activities are considered high risk that require additional controls to prevent damage to existing gas assets. This includes proving the existing gas asset location and depth for all horizontal bores, as well as providing a witness trench to verify that the bore will pass the asset with sufficient separation.

A witness trench must be used in addition to live electronic tracking of the bore head. The witness trench must be prepared to the specification provided in **Table 12**. The progressive measurement of the length of the bore must also be made and plotted along its proposed direction to ensure the bore head has not missed the witness trench. The bore head must be exposed in the witness trench, when the crossing is above the existing gas asset.

For all assets installed via trenchless excavation a vertical separation aligning with the maximum borehole diameter (e.g. reamed diameter) shall be demonstrated. For transmission pressure and distribution pressure assets this vertical separation distance is 1000 mm and 600 mm, respectively.

If the works run parallel to a transmission pressure or critical gas assets a minimum separation distance of 3 m must be maintained. For non-critical gas assets, the minimum separation distance of 1 m must be maintained. For works running parallel to gas assets, proving of the actual location of the gas asset must occur every 4 m.

Note: It is expected that HDD operators working near gas assets hold the national competency RIICCM202 – Identify, location and protect underground service.



Table 12 Minimum Witness Trench Dimensions

Crossing Type	Witness Trench Depth	Witness Trench Dimensions
Crossing Above Existing Gas Asset	To bottom (invert) of gas asset	Witness trench shall be 1000 mm to 2000 mm in front of the gas asset on the approach side. Witness trench shall be min. 1500 mm long and 300 mm wide centred on bore centre line.
Crossing Below Existing Gas Asset	To bottom (invert) of gas asset plus 500 mm	

Dispensation may be considered where detailed long sections are provided for assessment by APA and where depths of existing gas assets or separation to the bore are greater than 2500 mm.

Pipe bursting is not permitted within 1000 mm of an existing gas asset.

5.7 Piles, Piers or Poles

No piling such as pile-driving, sheet-piling or hammer-piling is permitted within 15 m of an existing gas asset unless explicit consent has been provided by APA. In all instances, vertical bored (augured) piles, piers or poles are preferred.

Where installation of piles, piers or poles are proposed between 500 mm and 1000 mm clearance from a gas asset (distribution and transmission pressures, respectively), the area directly below the proposed pile, pier or post location must be excavated to a level equivalent to the bottom (invert) of the existing gas asset, and works started from that depth.

Note: Proving of the gas asset must be completed in accordance with the requirements set out in **Section 5.5.2** prior to the commencement of any works.

Temporary steel plates may also be installed between the gas asset and the proposed pile, pier or post used for vertical bore methods within this clearance to provide extra protection.

Note: Direct vibration monitoring on the gas main may be required depending upon the installation method utilised. Refer to **Section 5.9** for APA Networks vibration limits.

5.8 Hot Works for Construction Activities

Typical hot works include grinding, welding, thermal or oxygen cutting or heating, and other related heat producing or spark-producing operations. Heat sources or hot works must not impact gas assets, taking into consideration that the ground or adjacent structures may also be capable of transmitting heat.

In order to safely undertake hot works, response procedures in the event of fire or flammable gas detection must be prepared and monitoring for flammable gases must be undertaken during works.

APA must approve any hot works where there is less than 300 mm ground cover to buried gas assets, or within 5,000 mm of any exposed gas assets (including any pits or valve covers). A heat shield or barrier may be required to provide protection if it cannot be demonstrated that works can be undertaken without impacting the gas asset.

5.9 Vibration Limits

Significant vibration may arise from activities such as blasting, piling, tunnelling and HDD/boring.

To avoid damage to existing APA Networks operated pipes and coatings, the following vibration limits must not be exceeded at any point on the pipe:

- a) For cast iron mains: 5 mm/s maximum Peak Particle Velocity (**PPV**) measured on the pipe.
- b) For steel pipe with a coal tar enamel (**CTE**) coating or with poor coating health: 10 mm/s maximum PPV measured on the pipe.
- c) For non-coal tar enamel pipe coatings and other pipe materials (i.e. steel, PE, PVC or Nylon): 20 mm/s maximum PPV measured on the pipe.



d) For blasting, the above vibration limits can be increased if supported by calculations in accordance with Design Guidelines for Buried Steel Pipeline – American Lifelines Alliance American Society of Civil Engineers (**ASCE**) and approved in writing by an APA Networks Integrity Engineer.

Note: Cast iron mains are particularly susceptible to damage by vibration. The PPV limit may not prevent leaks from cast iron and may require additional gas leakage survey activities during works in accordance with **Section 5.3**.

For vibration monitoring adopt an alarm at 80% of the acceptable PPV value and when the alarm is activated, the work must stop and be re-assessed. Short incursions up to 100% are acceptable, for sustained periods of vibration longer than 5 minutes, works must be stopped.

The zone of influence for vibration assessment undertaken by the third party is shown below;

- For compaction, refer to **Table 13**.
- For trenchless excavation (HDD/ boring), refer to **Section 5.6**.
- For piling refer to **Section 5.7**.
- For blasting refer to **Section 5.11**.

5.10 Compaction Limits

Compaction activities such as establishing a base course for a road pavement may result in damage to the pipes and coatings of existing gas assets. Compaction limits in the vicinity of existing gas assets are summarised in **Table 13**.

Table 13 Maximum Compaction Limits

Horizontal Separation (m)	Minimum Cover to Top of Gas Asset (mm)	Compaction Limits
≤3 (Note 1)	300	Small handheld compactor only
	500	Large handheld compactor Maximum 4 tonne tandem drum static roller
	750	Maximum 8 tonne tandem drum static roller
	1200	Maximum 10 tonne tandem drum static roller subject to APA approval
>3 & ≤10	All	Maximum 8 tonne tandem drum vibrating roller
>10 & ≤15	All	Maximum 10 tonne tandem drum vibrating roller
>15	All	Any compaction method

Note 1: Compaction within 3 m of gas assets is limited to static rollers. If vibration compaction is necessary a robust vibration assessment and construction methodology signed off by an RPEQ for works in Queensland, and so on as required for other States and Territories, will need to be produced by the third party for review and approval by an APA Networks Integrity Engineer.

5.11 Blasting / Seismic Survey / Explosives

Blasting, seismic survey or the use of explosives is not permitted within 100 m of a gas asset unless explicit approval is provided by APA Networks. The size and quantity of the explosives to be used will determine how close to the pipeline blasting will be permitted. In all cases, blasting methods must be arranged to limit ground vibrations so that the peak particle velocity does not exceed acceptable limits. At no stages will blasting be permitted within 3 m of the pipeline.



5.12 Suspended Materials above Gas Assets and No Go Zones for Cranes

Where gas assets are exposed, no cranes, excavators or backhoes are permitted to carry or suspend materials directly over or across a gas asset without an APA Networks approved lifting plan and SWMS.

Outriggers must be set up outside a 3 m radius from gas assets unless otherwise approved by APA Networks in writing.

5.13 Temporary Materials

In all instances it is preferred that temporary materials (e.g. soil, shipping containers) are not stored on top of transmission pressure and critical gas assets. Temporary material must not restrict access and should be placed at least 1,500 mm from the alignment of these assets unless otherwise approved by APA Networks.

6 PART 4 - ALTERATION OF EXISTING GAS ASSETS

Where the proposed third party works do not comply with the requirements of this document, and adequate additional controls or a specialised engineering solutions cannot be developed, alteration of the existing gas assets will be required.

Gas asset alterations will only be undertaken under a Recoverable Works Agreement (**RWA**) appropriate to the scope and extent of the works required.

An Early Works Agreement (**EWA**) may also be required where works are proposed which require proving, engineering design activities or purchase of long lead items. This will allow for completion of these items prior to execution of a RWA and avoid delaying works.

If either or both these agreements are required, then APA Networks will enter negotiations with the relevant third party and any costs will be payable by that third party.

7 GLOSSARY OF TERMS AND ABBREVIATIONS

Table 14 Glossary of Terms and Abbreviations

Term/ Abbreviation	Meaning
AGN	Australian Gas Networks
APA	Each entity that forms part of the APA Group
APA Engineering Assessment	Covers technical assessments which may involve field integrity assessments that may or may not include the use of specialist Consultants managed by APA.
APA Networks Operated Assets	APA Networks acts as the asset operator on behalf of entities Australian Gas Networks (AGN), Allgas, APA, Origin and Queensland Nitrates (QNP) and operates in New South Wales, Northern Territory, Queensland, South Australia and Victoria.
APA Permit Issuing Officer	The APA Permit Issuing Officer is responsible for opening the Permit To Work, validating APA Networks assets have been located and being the Site Watch for works within the gas Easement or Protected Zone.
AS	Australian Standard
ASCE	American Society of Civil Engineers
ATWP	Authority to Work Permit
CTE	Coal Tar Enamel
Damage	Physical damage to and interference with APA's assets. Damage includes reducing design life, coating damage, dents, scratches, rupture, cutting of cathodic protection cables. Damage can also include potential impacts that APA pipelines can have on third party assets.
BYDA	Before You Dig Australia (previously known as Dial Before You Dig (DBYD))
DCVG	Direct Current Voltage Gradient
Depth of Cover	Vertical distance from the existing natural ground surface to the top of the buried gas asset
EPR	Earth Potential Rise
ESV	Energy Safe Victoria
EWA	Early Works Agreement



Excavation	Excavation refers to manual digging or mechanised digging operation with plant or equipment which involves trenching and trenchless excavation. Trenchless excavation covers boring, Horizontal Directional Drilling (HDD), pipe bursting and tunnelling.
FBE	Fusion Bonded Epoxy
GIS	Geographic Information System
HBE	High Build Epoxy
HDD	Horizontal Directional Drilling
Hot Works	Hot works are defined as grinding, welding, thermal or oxygen cutting or heating, and other related heat-producing or spark-producing operations. Heat sources or hot works must not impact pipelines, taking into consideration that the ground or adjacent structures may also be capable of transmitting heat.
LFI	Low Frequency Induction
LPG	Liquefied Petroleum Gas
MAOP	Maximum Allowable Operating Pressure
Measurement Length	<p>The maximum length of pipeline route which presents an extended source of hazard on the basis that an event of failure could affect any part of the development or specific location relevant to the development.</p> <p>The maximum length corresponds to the heat radiation hazard associated with a 4.7 kW/m² heat radiation contour for an ignited full bore rupture calculated in accordance with AS/NZS 2885.6. If the pipeline is designed as a no rupture pipe, then the measurement length corresponds to a credible leak size.</p>
NDD	Non-Destructive Digging (NDD) refers to either hand digging or Non-Destructive Pot Holing using a vacuum pipe connected to a vacuum truck with either a water lance or air lance. Hydro-Vacuum Excavation consists of a water lance and vacuum truck and is used to physically prove existing assets.
OHEW	Overhead Earth Wire
PE	Polyethylene
Pipe Bursting	Pipe bursting refers to a pipe being inserted to a larger pipe that results in the larger pipe being damaged. For an example of pipe bursting, refer to the following You-Tube video: https://www.youtube.com/watch?v=HX5beh0ubGY
Pipeline Easement	The pipeline area shown on a survey plan and referenced on the property title.
Predominate Building Line	The expected predominate building line relates to the façade of the building, not necessarily the property boundary.
Protected Zone	A Protected Zone is an area extending both horizontally and longitudinally along a gas asset. It is the area where loads and/or any hot works may potentially cause damage to the gas asset.



	The Protected Zone refers to works near APA Networks gas assets or works within the vicinity of the gas assets that may cause an unacceptable risk to the asset in accordance with Table 2 Minimum Clearances or Table 3 Minimum Clearances for Construction Works and Land Use Activities
PTW	Permit to Work
PPV	Peak Particle Velocity
PVC	Polyvinyl Chloride
QNP	Queensland Nitrates Plant
RPEQ	Registered Profession Engineer Queensland
RWA	Recoverable Works Agreement
Sensitive Use Locations	<p>This is designated as Class “S” as per AS/NZS 2885.6 Pipelines - Gas and liquid petroleum - Pipeline safety management and refers to the sub location class.</p> <p>Sensitive Use Location Class (S) identifies land where the consequences of a FAILURE EVENT may be increased because it is developed for use by sectors of the community who may be unable to protect themselves from the consequences of a pipeline FAILURE EVENT.</p> <p>Sensitive uses are defined as follows:</p> <ul style="list-style-type: none"> • Schools which includes colleges • Hospitals • Aged care facilities such as nursing homes, elderly people’s homes • Prisons and jails • Convalescent homes • Sheltered housing • Buildings with five or more stories • Large community and leisure facilities, large open air gatherings • Day care facilities • Other potentially difficult to evacuate facilities • Other structures as defined by relevant local councils. <p>The Sensitive Use Location Class “S” must be assigned to any section of a gas transmission pipeline where there is a sensitive development within the applicable Measurement Length.</p>



<p>Site Watch</p>	<p>An APA Site Watch representative can be the Permit Issuing Officer for excavation work within a gas Easement or Protected Zone and is referred to as the primary spotter for excavation works.</p> <p>The secondary spotter is provided by the Contractor.</p> <p>The primary spotter has the ultimate decision regarding works within the gas Easement or Protected Zone which includes the method of excavation, starting and stopping excavation work.</p> <p>The APA Site Watch representative is the nominated competent person responsible for the following;</p> <ul style="list-style-type: none"> • Making themselves highly visible and everyone on the job site should be aware of the Site Watch’s role; • Communication to personnel operating mobile plant and equipment ensuring minimum clearance to above and below ground assets is maintained and the construction methodology is adhered to and complies with APA Networks requirements. <p>Ensuring personnel do not encroach within the swing radius of the operating machinery.</p>
<p>SMS</p>	<p>Safety Management Study</p>
<p>SMWS</p>	<p>Safe Work Method Statement used by APA or Contractors to execute field work. The risks and associated control measures risk assessments should be transferred to SWMS.</p>
<p>SRZ</p>	<p>Structural Root Zone</p>
<p>Structures</p>	<p>Structures refer to third party structures which includes, but is not limited to; temporary or permanent buildings, walls, canopies, footings, pile caps or retaining walls</p>
<p>Third Party</p>	<p>The person or entity and their agents or Contractors that propose to undertake work near APA assets.</p>
<p>Third Party Assets</p>	<p>Third Party Assets include roads, utilities and structures.</p>
<p>Third Party Excavation</p>	<p>Third Party Excavation which is not associated with APA (e.g. road works, utility installation, private development, fencing).</p>
<p>Third Party Works Classification</p>	<p>The Third Party Work Classification as shown in Section 3.3 covers the following three work classifications:</p> <ol style="list-style-type: none"> 1. No Impact to gas assets 2. No Objection Under Conditions 3. Enquiry Escalated for Alteration
<p>Transmission Pipeline</p>	<p>Gas transmission pipeline which includes all associated equipment such as cathodic protection, earthing grid, instrumentation and electrical cables.</p>
<p>Utilities</p>	<p>Includes water, wastewater, drainage, telecommunications cables, power poles and cables owned by individuals or organisations other than APA Networks.</p>
<p>Voltage</p>	<p>Difference of potential normally between conductors or between conductors and earth as follows:</p> <ol style="list-style-type: none"> a) Extra-low voltage – Not exceeding 50V a.c. or 120 V ripple-free d.c. b) Low voltage – Exceeding extra-low voltage, but not exceeding 1000 V a.c. or 1500 V d.c.

Guidelines for Works Near Existing Gas Assets
400-STD-AM-0001 Revision 2



	c) High voltage – Exceeding low voltage.
Works	The development of any type of buildings, structures and other obstructions (including residential buildings, pools, sheds, carports, major developments, transport infrastructure, services, stockpiles, trees), and any work that causes changes to the ground (including movement of heavy vehicles, blasting, tunnelling, pile driving, ground compaction, earthworks, open and trenchless excavations)

8 DOCUMENT REFERENCES

Table 15 Document References

External Standards	
API RP 1102	Steel Pipeline Crossing Railroads and Highways
AS 2832.1	Cathodic protection of metals: Pipes and cables
AS 2885.0	Pipelines – Gas and liquid petroleum: General requirements
AS/NZS 2885.1	Pipelines – Gas and liquid petroleum: Design and Construction
AS/NZS 2885.2	Pipelines – Gas and liquid petroleum: Welding
AS 2885.3	Pipelines – Gas and liquid petroleum: Operations and Maintenance
AS 2885.5	Pipelines – Gas and liquid petroleum: Field Pressure Testing
AS/NZS 2885.6	Pipelines – Gas and liquid petroleum: Pipeline safety management
AS/NZS 4645.1	Gas Distribution Networks - Network Management
AS/NZS 4645.2	Gas Distribution Networks - Steel Pipe Systems
AS/NZS 4645.3	Gas Distribution Networks - Plastics Pipe Systems
AS 4799	Installation of Underground Utility Services and Pipelines Within Railway Boundaries
AS 4827.1	Coating defect surveys for buried pipelines Part 1: Direct current voltage gradient (DCVG)
AS/NZS 4853	Electrical Hazards on Metallic Pipelines
AS 4970	Protection of trees on development sites
Standard Policies, Procedures, Specifications, Guidelines, Forms and Templates	
400-SP-L-0002	Networks Bedding Material Specification
400-PR-L-0003	Encroachment and Land Use Change SMS Trigger Procedure



APPENDIX A GENERAL DBYD RESPONSE PROCESS

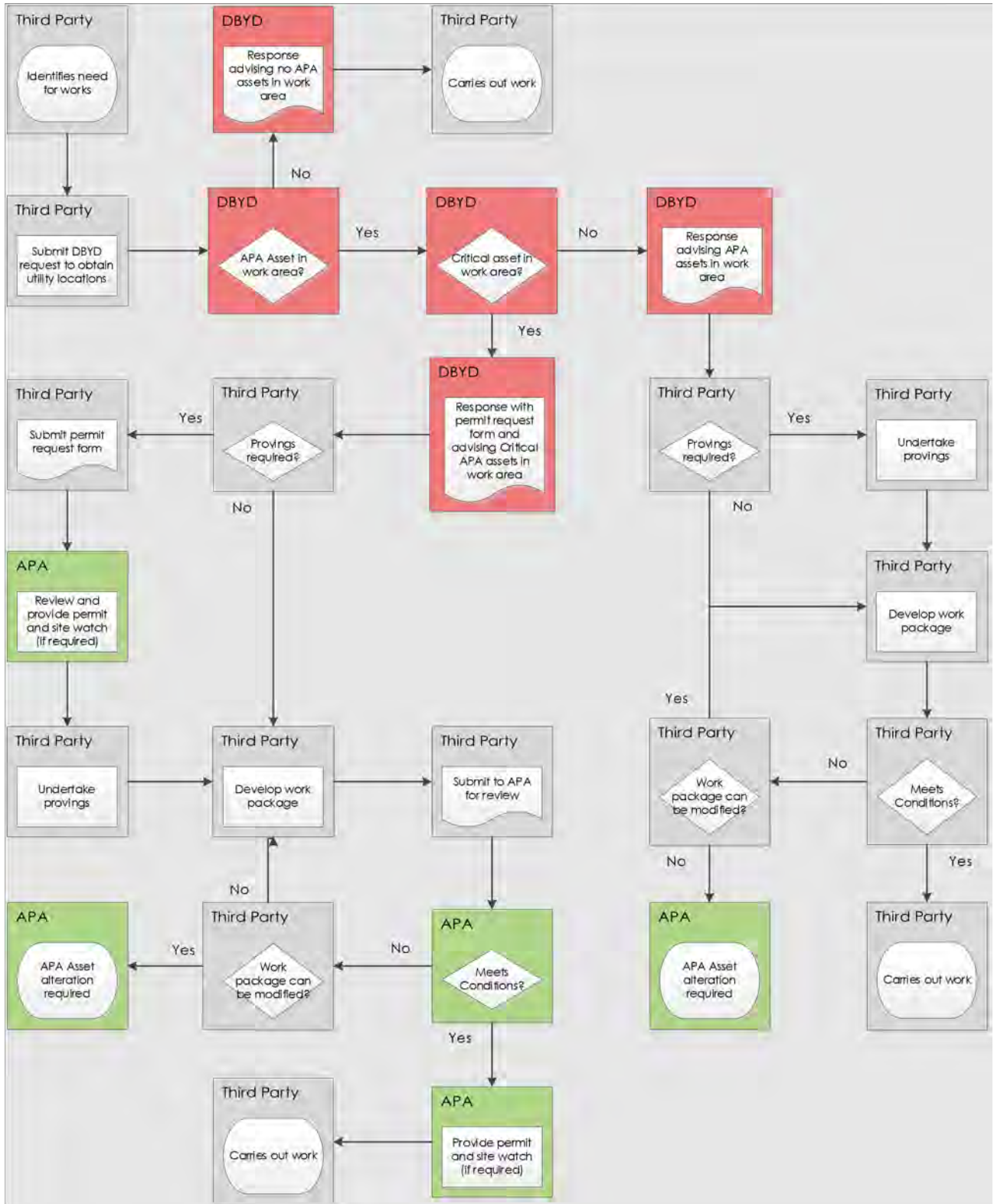

Job ID 51611592

Brisbane City Council

Referral
263708350

Member Phone
(07) 3403 8888

Responses from this member

Response received Wed 5 Nov 2025 11.55am

File name	Page
Response Body	57
ASSET 263708350.pdf	58

Attention: Info Request HPC

Thank you for your enquiry with Brisbane City Council's Before You Dig service.

Job Number: 51611592
Sequence Number: 263708350

The attached .PDF file contains the location of Council's relevant services for your requested location. If you are having trouble viewing these files, it is recommended you upgrade your version of Adobe Reader. You can download the latest version of Adobe Reader for free at <http://get.adobe.com/reader/>

If you require more information, Council offers a convenient online mapping subscription service containing additional services data. The online service offers a wide variety of spatial information suitable for searches over large areas, including information previously available only by visiting Council's Customer Service Centres.

For more information on Council's online mapping services, visit <http://www.brisbane.qld.gov.au/planning-building/planning-guidelines-and-tools/online-tools/ebimap/index.htm>

Kind regards,

Brisbane City Council
Before You Dig



Job # 51611592
Seq # 263708350
 Provider: Brisbane City Council
 Telephone: (07) 3403 8888



Legend

- BYDA Enquiry

Stormwater Network

- Stormwater Drain
- Stormwater Gully / Roofwater Connection
- Stormwater Maintenance Hole
- Stormwater Roofwater Pit
- Stormwater Gully Pit

Disclaimer:
 © Brisbane City Council [2020]
 In consideration of Council, and the copyright owners listed below, permitting the use of this data, you acknowledge and agree that Council, and the copyright owners, give no warranty in relation to the data (including accuracy, reliability, completeness, currency or suitability) and accept no liability (including without limitation, liability in negligence) for any loss, damage or costs (including consequential damage), relating to any use of this data.
 Data must not be used for direct marketing or be used in breach of the privacy laws.

Copyright of data is as follows:
 Cadastre and Street Names © 2020 State of Queensland (Department of Natural Resources, Mines and Energy)

Caution: This map may contain the locations of abandoned underground asbestos pipes. Council gives no warranty to the completeness or accuracy of these records. Appropriate care needs to be taken in all cases.

In an emergency contact Brisbane City Council on 07 3403 8888
05/11/25 (valid for 30 days)

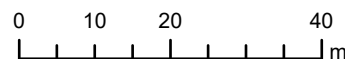

Scale 1:1,000



Plans generated by SmarterWX™ Automate

Job ID 51611592

NBN Co Qld

Referral
263708349

Member Phone
1800 687 626

Responses from this member

Response received Wed 5 Nov 2025 11.58am

File name	Page
Response Body	60
263708349_20251105_015739147884_1.pdf	61
4678_NBN_Dial_Before_You_Dig_Poster_20170517.pdf	64
Disclaimer_263708349_20251105_015739147884.pdf	66

Hi Info Request HPC,

Please find attached the response to your DBYD referral for the address mentioned in the subject line. The location shown in our DBYD response is assumed based off the information you have provided. If the location shown is different to the location of the excavation then this response will consequently be rendered invalid.

Take the time to read the response carefully and note that this information is only valid for 28 days after the date of issue.

If you have any further enquiries, please do not hesitate to contact us.

Regards,
Network Services and Operations
NBN Co Limited
P: 1800626329
E: dbyd@nbnco.com.au
www.nbnco.com.au

Confidentiality and Privilege Notice

This e-mail is intended only to be read or used by the addressee. It is confidential and may contain legally privileged information. If you are not the addressee indicated in this message (or responsible for delivery of the message to such person), you may not copy or deliver this message to anyone, and you should destroy this message and kindly notify the sender by reply e-mail. Confidentiality and legal privilege are not waived or lost by reason of mistaken delivery to you. Any views expressed in this message are those of the individual sender, except where the sender specifically states them to be the views of NBN Co Limited

Please Do Not Reply To This Mail

To: Info Request HPC
Phone: Not Supplied
Fax: Not Supplied
Email: inforequest.hpc@harcourts.com.au





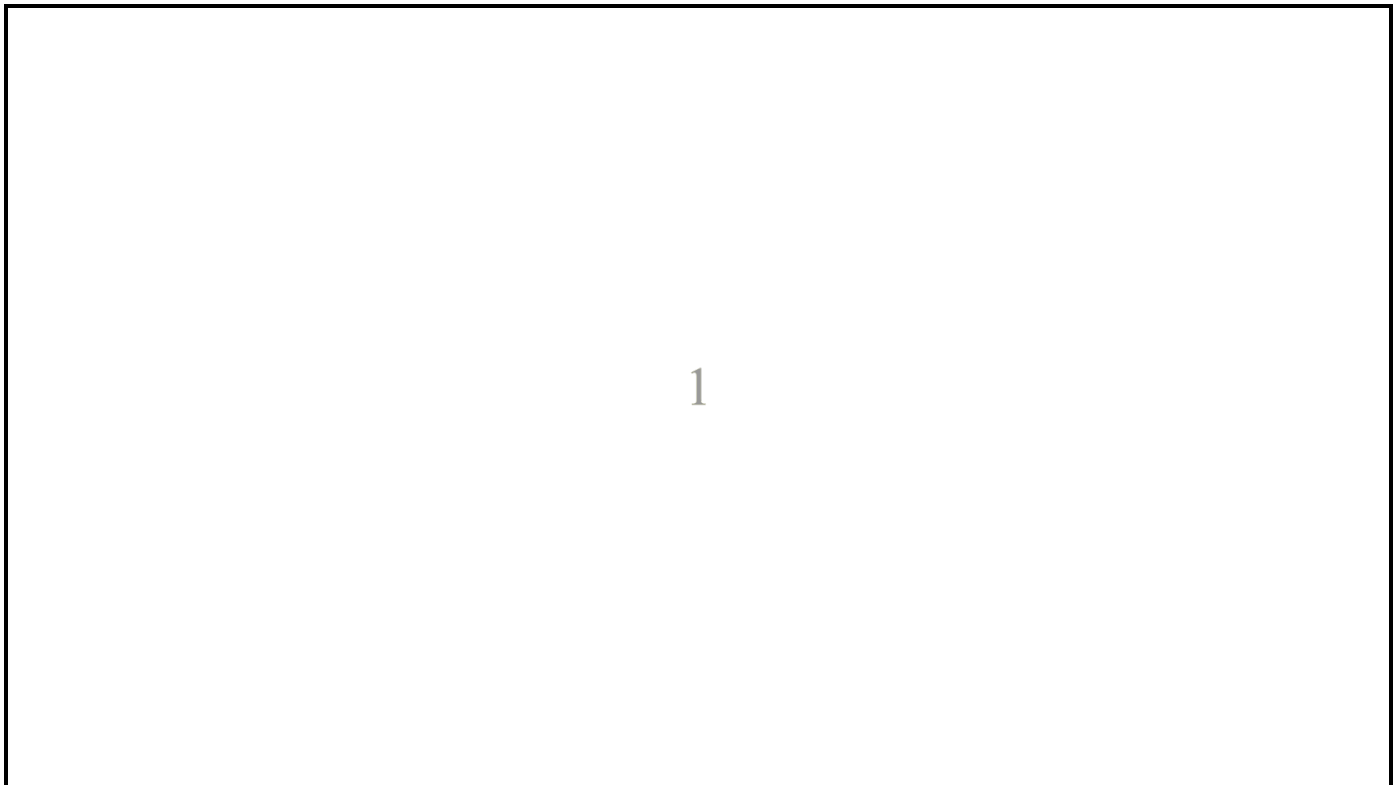

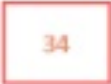

Dial before you dig Job #:	51611592	
Sequence #	263708349	
Issue Date:	05/11/2025	
Location:	24 Alkoomie St , Wynnum , QLD , 4178	

Indicative Plans are tiled below to demonstrate how to layout and read nbn asset plans



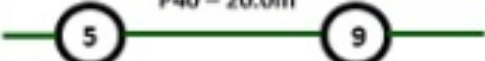
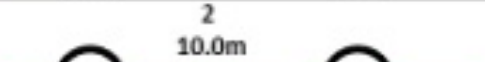

LEGEND

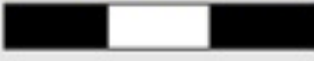
	Parcel and the location
	Pit with size "5"
	Power Pit with size "2E". Valid PIT Size: e.g. 2E, 5E, 6E, 8E, 9E, E, null.
	Manhole
	Pillar
<p>2 PO – T- 25.0m P40 – 20.0m</p> 	Cable count of trench is 2. One "Other size" PVC conduit (PO) owned by Telstra (-T-), between pits of sizes, "5" and "9" are 25.0m apart. One 40mm PVC conduit (P40) owned by NBN, between pits of sizes, "5" and "9" are 20.0m apart.
<p>2 10.0m</p> 	2 Direct buried cables between pits of sizes, "5" and "9" are 10.0m apart.
	Trench containing any INSERVICE/CONSTRUCTED (Copper/RF/Fibre) cables.
	Trench containing only DESIGNED/PLANNED (Copper/RF/Fibre/Power) cables.
	Trench containing any INSERVICE/CONSTRUCTED (Power) cables.
	Road and the street name "Broadway ST"
Scale	<p>0 20 40 60 Meters</p>  <p style="text-align: right;">1:2000 1 cm equals 20 m</p>



Working near nbn™ cables

nbn has partnered with Dial Before You Dig to give you a single point of contact to get information about **nbn** underground services owned by **nbn** and other utility/service providers in your area including communications, electricity, gas and other services. Contact with underground power cables and gas services can result in serious injury to the worker, and damage and costly repairs. You must familiarise yourself with all of the Referral Conditions (meaning the referral conditions referred to in the DBYD Notice provided by **nbn**).

Practice safe work habits

Once the DBYD plans are reviewed, the Five P's of Excavation should be adopted in conjunction with your safe work practices (which must be compliant with the relevant state Electrical Safety Act and Safe Work Australia "Excavation Work Code of Practice", as a minimum) to ensure the risk of any contact with underground **nbn** assets are minimised.



Plan: Plan your job by ensuring the plans received are current and apply to the work to be performed. Also check for any visual cues that may indicate the presence of services not covered in the DBYD plans.



Prepare: Prepare for your job by engaging a DBYD Certified Plant Locator to help interpret plans and identify on-site assets. Contact **nbn** should you require further assistance.



Pothole: Non-destructive potholing (i.e. hand digging or hydro excavation) should be used to positively locate **nbn** underground assets with minimal risk of contact and service damage.

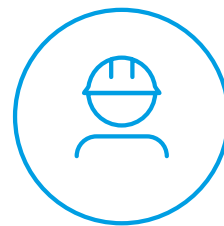

Protect: Protecting and supporting the exposed **nbn** underground asset is the responsibility of the worker. Exclusion zones for **nbn** assets are clearly stated in the plan and appropriate controls must be implemented to ensure that encroachment into the exclusion zone by machinery or activities with the potential to damage the asset is prevented.

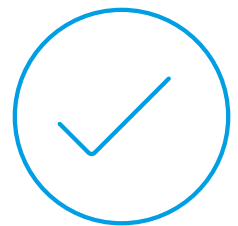

Proceed: Proceed only when the appropriate planning, preparation, potholing and protective measures are in place.

Working near **nbn**[™] cables

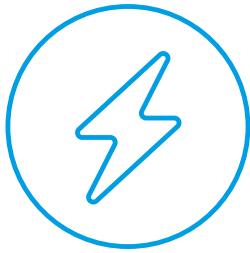

Identify all electrical hazards, assess the risks and establish control measures.

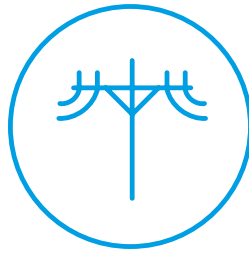

When using excavators and other machinery, also check the location of overhead power lines.

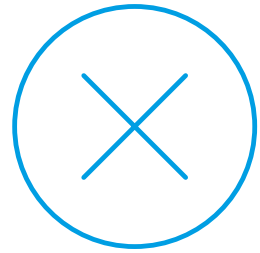

Workers and equipment must maintain safety exclusion zones around power lines.

Once all work is completed, the excavation should be re-instated with the same type of excavated material unless specified by **nbn**. Please note:

- Construction Partners of **nbn** may require additional controls to be in place when performing excavation activities.
- The information contained within this pamphlet must be used in conjunction with other material supplied as part of this request for information to adequately control the risk of potential asset damage.

Contact

All **nbn**[™] network facility damages must be reported online [here](#).
For enquiries related to your DBYD request please call 1800 626 329.

Disclaimer

This brochure is a guide only. It does not address all the matters you need to consider when working near our cables. You must familiarise yourself with other material provided (including the Referral Conditions) and make your own inquiries as appropriate.

nbn will not be liable or responsible for any loss, damage or costs incurred as a result of reliance on this brochure.

This document is provided for information purposes only. This document is subject to the information classification set out on this page. If no information classification has been included, this document must be treated as UNCLASSIFIED, SENSITIVE and must not be disclosed other than with the consent of nbn co. The recipient (including third parties) must make and rely on their own inquiries as to the currency, accuracy and completeness of the information contained herein and must not use this document other than with the consent of nbn co. Copyright © 2021 nbn co limited. All rights reserved.



To: Info Request HPC
Phone: Not Supplied
Fax: Not Supplied
Email: inforequest.hpc@harcourts.com.au

Before You Dig Australia Job #:	51611592	
Sequence #	263708349	
Issue Date:	05/11/2025	
Location:	24 Alkoomie St , Wynnum , QLD , 4178	

Information

The area of interest requested by you contains one or more assets.

nbn™ Assets	Search Results
Communications	Asset identified
Electricity	No assets

In this notice **nbn™ Facilities** means *underground fibre optic, telecommunications and/or power facilities, including but not limited to cables, owned and controlled by nbn™*

Location of nbn™ Underground Assets

We thank you for your enquiry. In relation to your enquiry at the above address:

- **nbn's** records indicate that there **ARE nbn™** Facilities in the vicinity of the location identified above ("Location").
- **nbn** indicative plan/s are attached with this notice ("Indicative Plans").
- The Indicative Plan/s show general depth and alignment information only and are not an exact, scale or accurate depiction of the location, depth and alignment of **nbn™** Facilities shown on the Plan/s.
- In particular, the fact that the Indicative Plans show that a facility is installed in a straight line, or at uniform depth along its length cannot be relied upon as evidence that the facility is, in fact, installed in a straight line or at uniform depth.
- You should read the Indicative Plans in conjunction with this notice and in particular, the notes below.
- You should note that, at the present time, the Indicative Plans are likely to be more accurate in showing location of fibre optics and telecommunications cables than power cables. There may be a variation between the line depicted on the Indicative Plans and the location of any power cables. As such, consistent with the notes below, particular care must be taken by you to make your own enquiries and investigations to precisely locate any power cables and manage the risk arising from such cables accordingly.
- The information contained in the Indicative Plan/s is valid for 28 days from the date of issue set out above. You are expected to make your own inquiries and perform your own investigations (including engaging appropriately qualified plant locators, e.g BYDA Certified Locators, at your cost to locate **nbn™** Facilities during any activities you carry out on site).

We thank you for your enquiry and appreciate your continued use of the Before You Dig Australia Service. For any enquiries related to moving assets or Planning and Design activities, please visit the [nbn Commercial Works](#) website to complete the online application form. If you are planning to excavate and require further information, please email dbyd@nbnco.com.au or call 1800 626 329.

Notes:

1. You are now aware that there are **nbn™** Facilities in the vicinity of the above property that could be damaged as a result activities carried out (or proposed to be carried out) by you in the vicinity of the Location.
2. You should have regard to section 474.6 and 474.7 of the *Criminal Code Act 1995* (CoA) which deals with the consequences of interfering or tampering with a telecommunications facility. Only persons authorised by **nbn** can interact with **nbn's** network facilities.
3. Any information provided is valid only for **28 days** from the date of issue set out above.

Referral Conditions

The following are conditions on which **nbn** provides you with the Indicative Plans. By accepting the plans, you are agreeing to these conditions. These conditions are in addition, and not in replacement of, any duties and obligations you have under applicable law.

1. **nbn** does not accept any responsibility for any inaccuracies of its plans including the Indicative Plans. You are expected to make your own inquiries and perform your own investigations (including engaging appropriately qualified plant locators, e.g BYDA Certified Locators, at your cost to locate **nbn™** Facilities during any activities you carry out on site).
2. You acknowledge that **nbn** has specifically notified you above that the Indicative Plans are likely to be more accurate in showing location of fibre optics and telecommunications cables than power cables. There may be a variation between the line depicted on the Indicative Plans and the location of any power cables.
3. You should not assume that **nbn™** Facilities follow straight lines or are installed at uniformed depths

along their lengths, even if they are indicated on plans provided to you. Careful onsite investigations are essential to locate the exact position of cables.

4. In carrying out any works in the vicinity of **nbn**™ Facilities, you must maintain the following minimum clearances:
 - 300mm when laying assets inline, horizontally or vertically.
 - 500mm when operating vibrating equipment, for example: jackhammers or vibrating plates.
 - 1000mm when operating mechanical excavators.
 - Adherence to clearances as directed by other asset owner's instructions and take into account any uncertainty for power cables.
5. You are aware that there are inherent risks and dangers associated with carrying out work in the vicinity of underground facilities (such as **nbn**™ fibre optic, copper and coaxial cables, and power cable feed to **nbn**™ assets). Damage to underground electric cables may result in:
 - Injury from electric shock or severe burns, with the possibility of death.
 - Interruption of the electricity supply to wide areas of the city.
 - Damage to your excavating plant.
 - Responsibility for the cost of repairs.
6. You must take all reasonable precautions to avoid damaging **nbn**™ Facilities. These precautions may include but not limited to the following:
 - All excavation sites should be examined for underground cables by careful hand excavation. Cable cover slabs if present must not be disturbed. Hand excavation needs to be undertaken with extreme care to minimise the likelihood of damage to the cable, for example: the blades of hand equipment should be aligned parallel to the line of the cable rather than digging across the cable.
 - If any undisclosed underground cables are located, notify **nbn** immediately.
 - All personnel must be properly briefed, particularly those associated with the use of earth-moving equipment, trenching, boring and pneumatic equipment.
 - The safety of the public and other workers must be ensured.
 - All excavations must be undertaken in accordance with all relevant legislation and regulations.
7. You will be responsible for all damage to **nbn**™ Facilities that are connected whether directly, or indirectly with work you carry out (or work that is carried out for you or on your behalf) at the Location. This will include, without limitation, all losses expenses incurred by **nbn** as a result of any such damage.
8. You must immediately report any damage to the **nbn**™ network that you are/become aware of. Notification may be by telephone - 1800 626 329.
9. Except to the extent that liability may not be capable of lawful exclusion, **nbn** and its servants and agents and the related bodies corporate of **nbn** and their servants and agents shall be under no liability whatsoever to any person for any loss or damage (including indirect or consequential loss or damage) however caused (including, without limitation, breach of contract negligence and/or breach of statute) which may be suffered or incurred from or in connection with this information sheet or any plans (including Indicative Plans) attached hereto. Except as expressly provided to the contrary in this information sheet or the attached plans (including Indicative Plans), all terms, conditions, warranties, undertakings or representations (whether expressed or implied) are excluded to the fullest extent permitted by law.

All works undertaken shall be in accordance with all relevant legislations, acts and regulations applicable to the particular state or territory of the Location. The following table lists all relevant documents that shall be considered and adhered to.

State/Territory	Documents
National	Work Health and Safety Act 2011
	Work Health and Safety Regulations 2011
	Safe Work Australia - Working in the Vicinity of Overhead and Underground Electric Lines (Draft)

	Occupational Health and Safety Act 1991
NSW	Electricity Supply Act 1995
	Work Cover NSW - Work Near Underground Assets Guide
	Work Cover NSW - Excavation Work: Code of Practice
VIC	Electricity Safety Act 1998
	Electricity Safety (Network Asset) Regulations 1999
QLD	Electrical Safety Act 2002
	Code of Practice for Working Near Exposed Live Parts
SA	Electricity Act 1996
TAS	Tasmanian Electricity Supply Industry Act 1995
WA	Electricity Act 1945
	Electricity Regulations 1947
NT	Electricity Reform Act 2005
	Electricity Reform (Safety and Technical) Regulations 2005
ACT	Electricity Act 1971

Thank You,

nbn BYDA

Date: 05/11/2025

This document is provided for information purposes only. This document is subject to the information classification set out on this page. If no information classification has been included, this document must be treated as UNCLASSIFIED, SENSITIVE and must not be disclosed other than with the consent of nbn co. The recipient (including third parties) must make and rely on their own inquiries as to the currency, accuracy and completeness of the information contained herein and must not use this document other than with the consent of nbn co.

Copyright © 2021 nbn co Limited. All rights reserved.

Job ID 51611592

Queensland Urban Utilities

Referral

263708351

Member Phone

13 26 57

Responses from this member

Response received Wed 5 Nov 2025 11.58am

File name

Page

Response Body

71

263708351 - Urban Utilities Plan.pdf

73

Urban Utilities Important Information.pdf

74



GPO Box 2765
Brisbane QLD 4001

Date: 05 Nov 2025

Before You Dig Australia Response

Please DO NOT SEND A REPLY to this email as it has been automatically generated and replies are not monitored.

Dear Info Request HPC

We appreciate your diligence in contacting the Before You Dig Australia service (**BYDA**) prior to engaging in work or activities which may affect the water and sewerage infrastructure of Urban Utilities.

Job Number:	51611592
Sequence Number:	263708351
Enquiry Date:	5/11/2025 12:55:00 PM
Enquiry Location:	24 Alkoomie St Wynnum QLD 4178

WARNING: When working in the vicinity of Urban Utilities' assets you have a legal *Duty of Care* that must be observed.

Our records indicate the presence of infrastructure owned by Urban Utilities within your nominated search area, as shown on the attached plan.

Please note that you may be liable for any loss or damage to our infrastructure which is caused by any works or activities which you undertake over or near such infrastructure. Additionally, your works or activities may conflict with other works scheduled in your nominated search area. To avoid any unnecessary impacts, before any undertaking you must obtain the following approvals:

- And/or a Urban Utilities Network Access Permit for self assessable works or activities that are within two metres of our infrastructure (refer to [Urban Utilities Network Access Permit Webpage](#))
- Either a Build Over Asset (BOA) Approval for assessable building works undertaken within specified distances of our infrastructure (refer to [DHPW BOA Factsheet](#))

We have provided additional information about your responsibilities in relation to our infrastructure in the Important Information sheet attached to this letter. By accessing BYDA to obtain our records about our infrastructure, you warrant that you have read the sheet and agree to the terms and conditions set out therein.

For further enquiries or assistance with interpretation of plans and search content please contact our BYDA Support Team by email networkaccess@urbanutilities.com.au. Alternatively, you can write to us at Urban Utilities, PO Box 2765, Brisbane QLD 4001.

Thank you for taking the time to consult the BYDA service.

Yours sincerely

Before You Dig Australia Support Team
Urban Utilities
networkaccess@urbanutilities.com.au

To best manage the risk of damage and liability, we recommend that you engage the services of a [BYDA Certified Locator](#)

Important Notice

This enquiry response, including any associated documentation, has been assessed and compiled from the information detailed within the BYDA enquiry outlined above. **Please ensure that the BYDA enquiry details and this response accurately reflect your proposed works.**

This response is intended for use only by the addressee. If you have received the enquiry response in error, please let us know by telephone and delete all copies; you are advised that copying, distributing, disclosing or otherwise acting in reliance on the response is expressly prohibited.

Disclaimer: While reasonable measures have been taken to ensure the accuracy of the information contained in this plan response, neither Urban Utilities nor PelicanCorp shall have any liability whatsoever in relation to any loss, damage, cost or expense arising from the use of this plan response or the information contained in it or the completeness or accuracy of such information. Use of such information is subject to and constitutes acceptance of these terms.

If you are unable to launch any of the files for viewing and printing, you may need to download and install free viewing and printing software such as [Adobe Acrobat Reader \(for PDF files\)](#).

Urban Utilities - Water, Recycled Water and Sewer Infrastructure

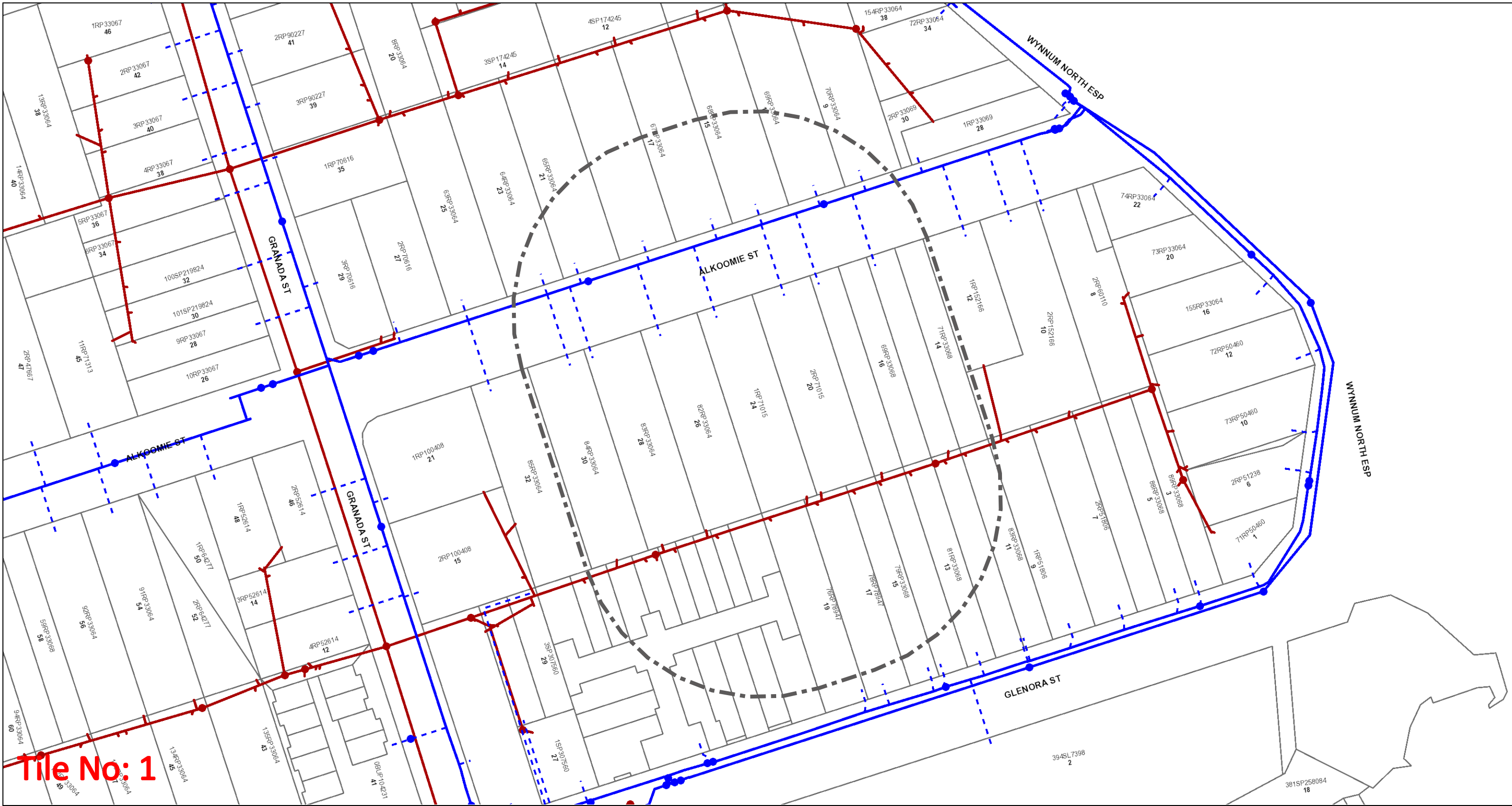

 <p>UrbanUtilities</p> <p>N</p> <p>Map Scale 1:1000</p>	<p>Before You Dig Australia- Urban Utilities Water, Recycled Water and Sewer Infrastructure</p> <p>BYDA Reference No: 263708351</p> <p>Date BYDA Ref Received: 05/11/2025 Date BYDA Job to Commence: 05/11/2025 Date BYDA Map Produced: 04/11/2025</p> <p>This Map is valid for 30 days Produced By: Urban Utilities</p>	<table border="0"> <tr> <th>Sewer</th> <th>Water</th> <th>Recycled Water</th> </tr> <tr> <td>● Infrastructure</td> <td>● Infrastructure</td> <td>● Infrastructure</td> </tr> <tr> <td>◆ Major Infrastructure</td> <td>◆ Major Infrastructure</td> <td>◆ Major Infrastructure</td> </tr> <tr> <td>— Network Pipelines</td> <td>— Network Pipelines</td> <td>— Network Pipelines</td> </tr> <tr> <td>▨ Network Structures</td> <td>▨ Network Structures</td> <td>▨ Network Structures</td> </tr> <tr> <td></td> <td>- - - Water Service (Indicative only)</td> <td></td> </tr> </table>	Sewer	Water	Recycled Water	● Infrastructure	● Infrastructure	● Infrastructure	◆ Major Infrastructure	◆ Major Infrastructure	◆ Major Infrastructure	— Network Pipelines	— Network Pipelines	— Network Pipelines	▨ Network Structures	▨ Network Structures	▨ Network Structures		- - - Water Service (Indicative only)		<p>While reasonable measures have been taken to ensure the accuracy of the information contained in this plan response, neither Urban Utilities nor PelicanCorp shall have any liability whatsoever in relation to any loss, damage, cost or expense arising from the use of this plan response or the information contained in it or the completeness or accuracy of such information. Use of such information is subject to and constitutes acceptance of these terms.</p> <p>The plans are indicative and approximate only and provided without warranties of any kind, express or implied including in relation to accuracy, completeness, correctness, currency or fitness for purpose.</p> <p>Urban Utilities takes no responsibility and accepts no liability for any loss, damage, costs or liability that may be incurred by any person acting in reliance on the information provided on the plans.</p> <p>This plan should be used as guide only. Any dimensions should be confirmed on site by the relevant authority.</p> <p>Based on or contains data provided by the State of Queensland (Department of Natural Resources and Mines) [2020]. In consideration of the State permitting the use of this data you acknowledge and agree that the State gives no warranty in relation to the data (including accuracy, liability in negligence) for any loss, damage or costs (including consequential damage) relating to any use of the data. Data must not be used for direct marketing or be used in breach of the privacy laws. © State of Queensland Department of Natural Resources and Mines [2020]</p> <p>For further information, please call Urban Utilities on 13 26 57 (8am-6pm weekdays). Faults and emergencies 13 23 64 (24/7). www.urbanutilities.com.au</p> <p>ABN 86 673 835 011</p>
Sewer	Water	Recycled Water																			
● Infrastructure	● Infrastructure	● Infrastructure																			
◆ Major Infrastructure	◆ Major Infrastructure	◆ Major Infrastructure																			
— Network Pipelines	— Network Pipelines	— Network Pipelines																			
▨ Network Structures	▨ Network Structures	▨ Network Structures																			
	- - - Water Service (Indicative only)																				

Important Information

Disclaimer

All Urban Utilities' records, data and information supplied via BYDA ("**Data**") is **indicative** only. You agree that any Data supplied to you has been or will be provided only for your convenience and has not been and will not be relied upon by you for any purpose.

You also agree that Urban Utilities does not assume any responsibility or duty of care in respect of, or warrant, guarantee or make any representation as to the Data (including its accuracy, reliability, currency or suitability).

Because the location of Urban Utilities' infrastructure shown on the Data is approximate only, you must first physically locate the infrastructure by utilising relevant site detection methodologies prior to performing any works or undertaking any activities near or adjacent to infrastructure. Possible site detection methodologies include hand digging, potholing, trenching and/or probing. You are solely responsible for the selection of appropriate site detection methodologies at all times.

To the fullest extent permitted by law, Urban Utilities will not be liable to you in contract, tort, equity, under statute or otherwise arising from or in connection with the provision of any Data to you via BYDA.

Compliance with laws

There may be both indicated and unmarked hazards, dangers or encumbrances, including underground asbestos pipes and abandoned mains within your nominated search area. You are solely responsible for ensuring that appropriate care is taken at all times and that you comply with all mandatory requirements relating to such matters, including in relation to workplace health and safety.

Damaged Infrastructure

Please note that it is an offence under Section 192 of the *Water Supply (Safety and Reliability) Act 2008* to interfere with our infrastructure without Urban Utilities' written consent.

You may be liable to Urban Utilities for any loss of or damage to our infrastructure, together with any consequential or indirect loss or damage (including without limitation, loss of use, loss of profits or loss of revenue) arising from or in connection with any interference with Urban Utilities' infrastructure by you or any other person for which you are legally responsible.

Any damage to Urban Utilities' Infrastructure must be reported immediately to the (24 Hours) Faults and Emergencies Team on 13 23 64.

Links

Technical Standards: <https://urbanutilities.com.au/development/help-and-advice/standards-and-guidelines>

Copyright

All Data is copyright.

Job ID 51611592

Telstra QLD South East

Referral
263708353

Member Phone
1800 653 935

Responses from this member

Response received Wed 5 Nov 2025 12.07pm

File name	Page
Response Body	76
263708353.pdf	78
AccreditedPlantLocators 2025-09-16a.pdf	79
Telstra Duty of Care v33.0a.pdf	80
Telstra Map Legend v4_0c.pdf	82



Attention: Info Request HPC

Site Location: 24 Alkoomie St, Wynnum, QLD 4178

Your Job Reference: 24 Alkoomie St

Please do not reply to this email, this is an automated message -

Thank you for requesting Telstra information via Before You Dig Australia (BYDA). This response contains Telstra Information relating to your recent request.





 Accredited Plant Locator	General Contact Information including applications required to view Cable Plans - DWF & PDF
 Telstra Duty of Care V32	Your responsibility and Legal requirements working near Telstra's Assets
 Telstra Map Legend 4.0	Common Symbols on Cable Plans and Safe Clearance distances when working near Telstra Assets



Please note:

When working in the vicinity of telecommunications plant you have a 'Duty of Care' that must be observed.

Ensure you read all documents (attached) - they contain important information.

In particular please read and familiarise yourself with the Before you Dig Australia - BEST PRACTISE GUIDES and The five Ps of safe excavation <https://www.byda.com.au/before-you-dig/best-practice-guides/>, as these documents set out the essential steps that must be undertaken prior to commencing construction activities.

 <p>Best practice guides and the five P's of safe excavation</p>	<p>These are the essential steps to be undertaken prior to commencing construction activities</p>	<p>Essential Steps : Link 5 P's: Link</p>
	<p>We highly recommend using certified locators where possible.</p>	<p>CERTLOC : Link</p>
 <p>1800 653 935 Telstra Plan Services</p>	<p>Whenever in doubt please contact this number for Telstra BYDA map related enquiries email Telstra.Plans@team.telstra.com</p>	<p>Note: that Telstra plans are only valid for 60 days from the date of issue</p>
 <p>How to Report Damage to Telstra Equipment</p>	<p>If you think you have damaged Telstra Assets, please Report it ASAP.</p>	<p>Call: 13 22 03 Report Online: Link</p>

	<p>It is a criminal offence under the 'Criminal code act 1995' to tamper or interfere with Telecommunications infrastructure. Telstra will take action to recover compensation for the damage caused to property and assets, and for interference with the operation of Telstra's networks and customer service.</p>
	<p>Telstra plans contain confidential information and are provided on the basis that they are used solely for identifying location or vicinity of Telstra's infrastructure to avoid damage to this infrastructure occurring as part of any digging or other excavation activity. You must not use Telstra's plans for any other purpose or in a way that will cause loss or damage. You must comply with any other terms of access to the data that have been provided by you by Telstra (including conditions of use or access).</p>

WARNING: Telstra plans and location information conform to Quality Level 'D' of the Australian Standard AS 5488 - Classification of Subsurface Utility Information. As such, Telstra supplied location information is indicative only. Spatial accuracy is not applicable to Quality Level D. Refer to AS 5488 for further details. The exact position of Telstra assets can only be validated by physically exposing them. Telstra does not warrant or hold out that its plans are accurate and accepts no responsibility for any inaccuracy. Further on site investigation is required to validate the exact location of Telstra assets prior to commencing work. A Certified Locating Organisation is an essential part of the process to validate the exact location of Telstra assets and to ensure the assets are protected during construction works.

See the **Before You Dig Australia - BEST PRACTISE GUIDES and The five Ps of safe excavation**
[https://www.byda.com.au/before-you-dig/best-practice-guides/..](https://www.byda.com.au/before-you-dig/best-practice-guides/)

Please note that:

- it is a criminal offence under the *Criminal Code Act 1995* (Cth) to tamper or interfere with telecommunications infrastructure.
- Telstra will take action to recover compensation for damage caused to property and assets, and for interference with the operation of Telstra's networks and customers' services.

Telstra's plans contain Telstra's confidential information and are provided on the basis that they are used solely for identifying the location or vicinity of Telstra's infrastructure to avoid damage to this infrastructure occurring as part of any digging or other excavation activity. You must not use Telstra's plans for any other purpose or in a way that will cause Telstra loss or damage and you must comply with any other terms of access to the data that have been provided to you by Telstra (including Conditions of Use or Access).

(See attached file: *Telstra Duty of Care v33.0a.pdf*)

(See attached file: *Telstra Map Legend v4_0c.pdf*)

(See attached file: *AccreditedPlantLocators 2025-09-16a.pdf*)

(See attached file: *263708353.pdf*)



General Information

Before you Dig Australia – BEST PRACTISE GUIDES
<https://www.byda.com.au/before-you-dig/best-practice-guides/>

OPENING ELECTRONIC MAP ATTACHMENTS –

Telstra Cable Plans are generated automatically in either PDF or DWF file types. Dependent on the site address and the size of area selected. You may need to download and install free viewing software from the internet e.g.



DWF Map Files (all sizes over A3)
 Autodesk Viewer (Internet Browser) <https://viewer.autodesk.com/> or
 Autodesk Design Review <http://usa.autodesk.com/design-review/> for DWF files.
 (Windows PC)



PDF Map Files (max size A3)
 Adobe Acrobat Reader <http://get.adobe.com/reader/>



Telstra New Connections / Disconnections
 13 22 00



Telstra Protection & Relocation: 1800 810 443 (AEST business hours only).
[Email](#)
 Telstra Protection & Relocation Fact Sheet: [Link](#)
 Telstra Protection & Relocation Home Page [Link](#)



Telstra Aerial Assets Group (overhead network)
 1800 047 909

Protect our Network:

by maintaining the following distances from our assets:

- **1.0m Mechanical Excavators, Farm Ploughing, Tree Removal**
- **500mm Vibrating Plate or Wacker Packer Compactor**
- **600mm Heavy Vehicle Traffic (over 3 tonnes) not to be driven across Telstra ducts or plant.**
- **1.0m Jackhammers/Pneumatic Breakers**
- **2.0m Boring Equipment (in-line, horizontal and vertical)**

For more info contact a [CERTLOC Certified Locating Organisation \(CLO\)](#) or
Telstra Location Intelligence Team 1800 653 935



Before You Dig Australia

Think before you dig

This document has been sent to you because you requested plans of the Telstra network through Before You Dig Australia (BYDA).

If you are working or excavating near telecommunications cables, or there is a chance that cables are located near your site, you are responsible to avoid causing damage to the Telstra network.

Please read this document carefully. Taking your time now and following the **BYDA's Best Practices and 5 Ps of Safe Excavation** <https://www.byda.com.au/before-you-dig/best-practice-guides/>

can help you avoid damaging our network, interrupting services, and potentially incurring civil and criminal penalties.

Our network is complex and working near it requires expert knowledge. Do not attempt these activities if you are not qualified to do so.



Disclaimer and legal details

*Telstra advises that the accuracy of the information provided by Telstra conforms to Quality Level D as defined in AS5488-2013.

It is a criminal offence under the Criminal Code Act 1995 (Cth) to tamper or interfere with telecommunications infrastructure.

Telstra will also take action to recover costs and damages from persons who damage assets or interfere with the operation of **Telstra's** networks.

By receiving this information including the indicative plans that are provided as part of this information package you confirm that you understand and accept the risks of working near **Telstra's** network and the importance of taking all the necessary steps to confirm the presence, alignments and various depths of **Telstra's** network. This in addition to, and not in replacement of, any duties and obligations you have under applicable law.

When working in the vicinity of a telecommunications plant you have a "Duty of Care" that must be observed. Please read and understand all the information and disclaimers provided below.

The Telstra network is complex and requires expert knowledge to interpret information, to identify and locate components, to pothole underground assets for validation and to safely work around assets without causing damage. If you are not an expert and/or qualified in these areas, then you must not attempt these activities. Telstra will seek compensation for damages caused to its property and losses caused to Telstra and its customers. Construction activities and/or any activities that potentially may impact on Telstra's assets must not commence without first undertaking these steps. Construction activities can include anything that involves breaking ground, potentially affecting Telstra assets.

If you are designing a project, it is recommended that you also undertake these steps to validate underground assets prior to committing to your design.

This Notice has been provided as a guide only and may not provide you with all the information that is required for you to determine what assets are on or near your site of interest. You will also need to collate and understand all information received from other Utilities and understand that some Utilities are not a part of the BYDA program and make your own enquiries as appropriate. It is the responsibility of the entities arranging for the works to be performed, supervising the works, and undertaking the works to protect Telstra network during excavation / construction works.

Telstra owns and retains the copyright in all plans and details provided in conjunction with the applicant's request. The applicant is authorised to use the plans and details only for the purpose indicated in the applicant's request. The applicant must not use the plans or details for any other purpose.

Telstra plans or other details are provided only for the use of the applicant, its servants, agents, or CERTLOC Certified Locating Organisation (CLO). The applicant must not give the plans or details to any parties other than these and must not generate profit from commercialising the plans or details. If the Applicant is aware of another party or parties about to perform or performing works at the location, it should ensure that the other party or parties have lodged a BYDA enquiry and obtained plans for that location. If you are undertaking excavations works you must follow the 5Ps of Safe Excavation. The 5 Ps of Safe Excavation are set out in the video in the below link.

<https://www.byda.com.au/education/resources/>

Telstra, its servants or agents shall not be liable for any loss or damage caused or occasioned by the use of plans and or details so supplied to the applicant, its servants and agents, and the applicant agrees to indemnify Telstra against any claim or demand for any such loss or damage.

Please ensure Telstra plans and information provided always remains on-site throughout the inspection, location, and construction phase of any works.

Telstra plans are valid for 60 days after issue and must be replaced if required after the 60 days.

Data Extraction Fees

In some instances, a data extraction fee may be applicable for the supply of Telstra information. Typically, a data extraction fee may apply to large projects, planning and design requests or requests to be supplied in non-standard formats. For further details contact Telstra Location Intelligence Team.

Telstra does not accept any liability or responsibility for the performance of or advice given by a CERTLOC Certified Locating Organisation (CLO). Certification is an initiative taken by Telstra towards the establishment and maintenance of competency standards. However, performance and the advice given will always depend on the nature of the individual engagement.

Neither the Certified Locating Organisation nor any of its employees are an employee or agent for Telstra. Telstra is not liable for any damage or loss caused by the Certified Locating Organisation or its employees.

Once all work is completed, the excavation should be reinstated with the same type of excavated material unless specified by Telstra.

The information contained within this pamphlet must be used in conjunction with other material supplied as part of this request for information to adequately control the risk of potential asset damage.

When using excavators and other machinery, also check the location of overhead power lines.

Workers and equipment must maintain safety exclusion zones around power lines

WARNING: Telstra plans and location information conform to Quality Level 'D' of the Australian Standard AS 5488 - Classification of Subsurface Utility Information. As such, Telstra supplied location information is indicative only. Spatial accuracy is not applicable to Quality Level D. Refer to AS 5488 for further details. Telstra does not warrant or hold out that its plans are accurate and accepts no responsibility for any inaccuracy shown on the plans. **FURTHER ON SITE INVESTIGATION IS REQUIRED TO VALIDATE THE EXACT LOCATION OF TELSTRA PLANT PRIOR TO COMMENCING CONSTRUCTION WORK.** A plant location service is an essential part of the process to validate the exact location of Telstra assets and to ensure the assets are protected during construction works. The exact position of Telstra assets can only be validated by physically exposing them. Telstra will seek compensation for damages caused to its property and losses caused to Telstra and its customers.

Privacy Note

Your information has been provided to Telstra by BYDA to enable Telstra to respond to your BYDA request. Telstra keeps your information in accordance with its privacy statement. You can obtain a copy at www.telstra.com.au/privacy or by calling us at 1800 039 059 (business hours only).



LEGEND

	Lead-in terminates at a Customer Address
	Exchange Major Cable Present
	Pillar / Cabinet Above ground Free Standing
	Above ground Complex Equipment Please note: Powered by 240v electricity
OC	Other Carrier Telecommunication Cable/ Asset. Not Telstra Owned
DIST	Distribution cables in Main Cable Ducts
MC	Main Cable ducts on a Distribution Plan
	Blocked or Damaged Duct
	Footway Access Chamber (can vary between 1-lid to 12-lid)
	NBN Pillar
	Third Party Owned Network Non-Telstra

	Cable Jointing Pit Number / Letter indicating Pit type/size
	Elevated Joint (above ground joint on buried cable)
	Telstra Plant in shared Utility trench
	Aerial cable / or cable on wall
	Aerial cable (attached to joint use Pole e.g., Power Pole)
	Marker Post Installed
	Buried Transponder
	Marker Post & Transponder
	Optical Fibre Cable Direct Buried
	Direct Buried Cable
	nbn owned network

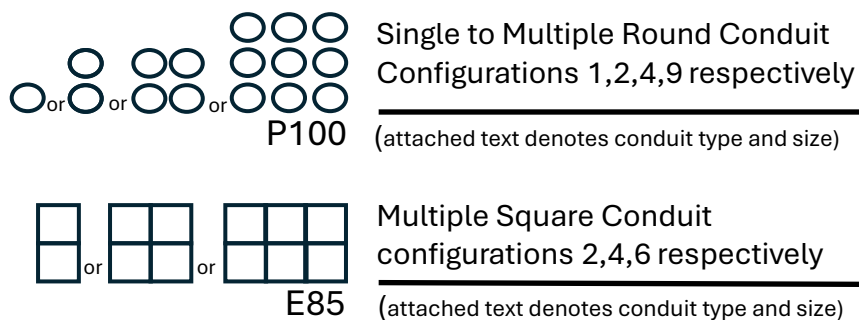

Some examples of conduit type and size:

A - Asbestos cement, P - PVC / Plastic, C - Concrete, GI - Galvanised Iron, E - Earthenware

Conduit sizes nominally range from 20mm to 100mm

P50 50mm PVC conduit
P100 100mm PVC conduit
A100 100mm asbestos cement conduit

Some Examples of how to read Telstra Plans

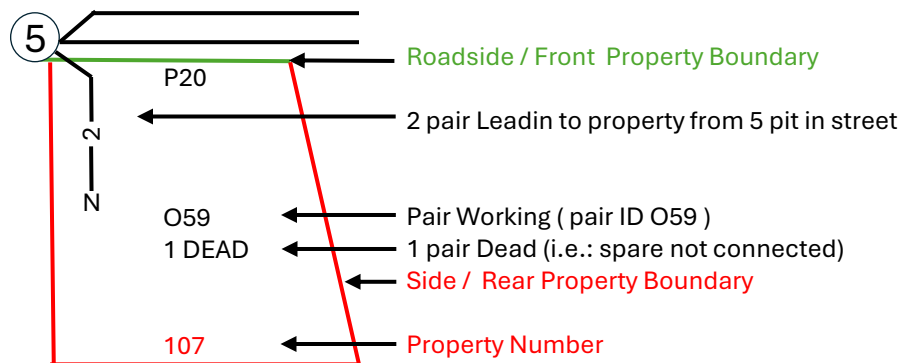
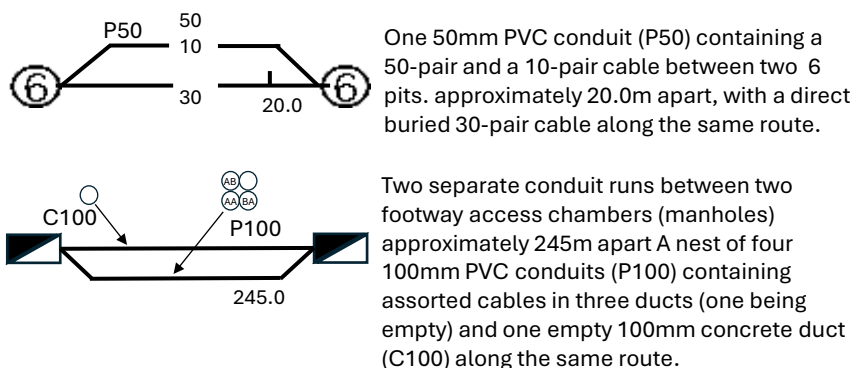

The 5 Ps of Safe Excavation

<https://www.byda.com.au/before-you-dig/best-practice-guides/>

Plan

Plan your job. Use the BYDA service at least one day before your job is due to begin, and ensure you have the correct plans and information required to carry out a safe project.

Prepare

Prepare by communicating with asset owners if you need assistance. Look for clues onsite. Engage a Certified Locator.

Pothole

Potholing is physically sighting the asset by hand digging or hydro vacuum extraction.

Protect

Protecting and supporting the exposed infrastructure is the responsibility of the excavator. Always erect safety barriers in areas of risk and enforce exclusion zones.

Proceed

Only proceed with your excavation work after planning, preparing, potholing (unless prohibited), and having protective measures in place.



End of document

i This document may exclude some files (eg. DWF or ZIP files)

This document was automatically generated at a point-in-time. Be aware that the source information from which this document was created may have changed since it was produced. This document may contain incomplete or out-of-date information. Always check your enquiry details in the BYDA Referral Service for the most recent information. For copyright information refer to individual responses.